

sunflower®



Medical Equipment Product Range





UK's leading **manufacturer** of healthcare furniture



Based in Braford, West Yorkshire we are proud of our UK manufacturing facility which undertakes its design, manufacturing, assembly and distribution all from one central site. Having the ability to design new innovative products, manufacture and supply them from start to finish allows us to provide bespoke solutions and outstanding levels of service.



our promise

To create smart, contemporary, functional furniture, we start with intuitive design and solid engineering. Then, we use the best materials and subject our products to rigorous testing. That's what makes a Sunflower product and why our warranty and service is a **real promise**.



We **manufacture** on site and in the UK



Our CNC, machining, drilling, spraying and pressing facilities enable us to manufacture accurately and quickly in response to customer requirements, whether it be for a single item or a large quantity in a specific colour or finish, while still being flexible on delivery times.



In-house design with **3D CAD** technology



Our specialised product designers have many years of experience in the healthcare market. Designing from 'concept to reality' using the latest solid modelling CAD software our designers can create anything from a new single product, something bespoke or a whole new room or environment to your exact requirements.

our products & service

We design medical furniture to help healthcare become more efficient, combined with high service levels, extensive warranties and consideration for the environment.

We believe passionately in innovative design and continuous development, utilise modern materials and technology to produce stylish and hygienic new products and solutions.

Ease of cleaning and hygienic design is carefully incorporated into everything we do.

We are committed to reducing our impact on the environment and utilise sustainable materials and sources wherever possible, achieving ISO and FSC standards. We are committed to recognised industry standards, giving you confidence in our company, our products and our people.



Certified Number 5288
ISO 9001



Certified Number 5288
ISO 14001



FSC The mark of
responsible forestry



Membership No:
00334186



FIRA Standard 6250
2005 Specification:
Adhesion Performance
General/Severe



BS EN 16139: 2013
Furniture Strength,
Durability & Safety



Anti-bacterial Vinyl Strength Test
BS EN ISO 13934-1: 2013
BS EN ISO 13973-3: 2000
BS EN ISO 12947-2: 1998



Fire (Flammability) Testing
Flammability BS 7176 Medium Hazard
BS 5852 : 2006 Clause 11
(composites)



Suppliers to the NHS

NHS Supply Chain Contract:
Medical Furniture & Sack Holders (FAG15887-OJEU ref: 2014/S 198-349358)

NHS Supply Chain Contract:
Ward & Residential Furniture (FAG000016544-OJEU ref: 2017/S 056-104552)

NHS Shared Business Services Contract:
Medical Furniture (SBS/16/SB/TBP/9050/12 – OJEU 2016/S 174-312172)

For more details visit my.supplychain.nhs.uk/catalogue



Warranty

We provide a minimum 1 year warranty on all products, with the majority having between 2 to 5 years and some components for life, giving you complete peace of mind.



Express Delivery

Need an item quickly? - We offer a range of products through our express system with delivery normally within 3-5 working days, just look for the Express symbol.



Delivery & Installation

We can deliver and install your new furniture anywhere in the UK using our own vehicles and trained installers, please enquire for further details.



New Build, Equipping and Refurbishment

We offer a bespoke design, manufacture, fitting and project management service for new or existing healthcare premises. Visit our website for our full service solutions and case studies.



Export

We can export our products worldwide and have established distributors around the globe. Contact our export department at export@sunflowermedical.co.uk for further details, or if you would like to become part of our global distributor network.

Contact Us & How To Order

T: +44 (0)1274 684004

F: +44 (0)1274 684006

E: sales@sunflowermedical.co.uk

Contact us with your requirements or for details of our approved national distributors.

Alternatively buy online at: www.sunflowermedical.co.uk

new products



We believe designing new products is a process of evolution, and is one element that makes Sunflower different. We start with detailed customer research, so we understand your needs and requirements, and then we use the latest CAD technology to model initial concepts, build prototypes, and then test them in the environment prior to production. That's why and how we design **new products.**



contents

Couches, Plinths & Accessories	Page 1 - 43
Phlebotomy Chairs, Operator Chairs & Stools	Page 44 - 54
Vista Trolleys & Storage	Page 55 - 91
Dressing & Surgical Trolleys, Theatre Equipment	Page 92 - 106
Medicine & Controlled Drug Cabinets	Page 107 - 125
Bins & Sack Holders	Page 126 - 130
Mobile Screens	Page 131 - 135
Mirrors & Mobile Drip Stands	Page 136 - 140
Furniture Packages	Page 141 - 143
Cabinet Ranges	Page 144 - 148
Integrated Plumbing Systems, Sinks & Taps	Page 149 - 161
Visitor, Patient & Waiting Room Seating	Page 162 - 190
Desks, Chairs, Filing, & Administration Storage	Page 191 - 207
Drug, Medicine, Records Trolleys, & Pharmacy Fridges	Page 208 - 224
Overbed Tables, Bedside Furniture & Patient Seating	Page 225 - 251
Recommended Cleaning Guidelines	Page 252 - 253
Upholstery and KYDEX® Colours	Page 254 - 256

clean
simple
examination

Couches & Accessories

We design couches for most medical applications, from treatment, gynecological and examination to resting and portable use, all with optional accessories to make procedures easier.

	Fusion Classic Plus+ Variable Height Couches	PAGE 2-3		Treatment Couch Systems	PAGE 28-35
	Fusion Classic Variable Height Couches	4-7		Deluxe Examination Couches	36-37
	Fusion Eco Variable Height Couches	8-11		Examination Couches	38-39
	Fusion Gynae Variable Height Couches	12-15		Rest Couches	40-41
	Fusion Drop End Multi-Discipline Couches	16-17		Portable Couches	42-43
	Fusion Podiatry Chairs	18-19		Couch Steps	42-43
	Fusion Treatment Chairs	20-21			
	Treatment Chairs	22-23			
	Fusion Phlebotomy Chairs	24-25			
	Phlebotomy Chairs	26-27			

product information

Fully powered height adjustment 45-96cm	Fully powered multi-position head section +70° / -35°	Fully powered multi-position foot section +70° / -35°	Maximum user weight (35st.)	Easy to use handset
Retractable positioning castors	Adjustable height levelling foot	Fully upholstered head & foot sections	Double layer density foam for support & comfort	Luxury 65mm deep contoured upholstery
Anti-bacterial/anti-microbial vinyl	Paper roll holder (supplied as standard)	Easy clean design and materials	Anti-bacterial Vinyl Strength Test BS EN ISO 13934-1: 2013 BS EN ISO 13973-3: 2000 BS EN ISO 12947-2: 1998	Fire (Flammability) Testing Flammability BS 7176 Medium Hazard BS 5852 : 2006 Clause 11 (composites)

accessories * these accessories can only be fitted when ordered with the couch

Sun-FVHC/LEG1 Leg Supports	Sun-FVHC/PHB1 Phlebotomy Arm (each)	Sun-FVHC/FSW1* Foot Switch	Sun-FVHC/FSW2* Foot Switch 2 Section	Sun-FVHC/FSW3* Foot Switch 3 Section
Sun-FVHC/SUP1 Gynae Stirrups	Sun-CHP1 Head Pillow	Sun-FVHC/CBH1* Breathing Hole	Sun-FVHC/CSR* Folding Side Rails (pair)	Sun-FVHC/IV2* IV Pole Attachment
Sun-FVHC/RAIL* Medi-Rail Attachment	Sun-FVHC/BB* Battery Backup	Installation Service & Packaging Recycling	Sun-DISPOSAL1*/** Removal & Disposal of Old Couch	** Removal from ground floor only - weight & removal restrictions apply, please enquire

dimensions

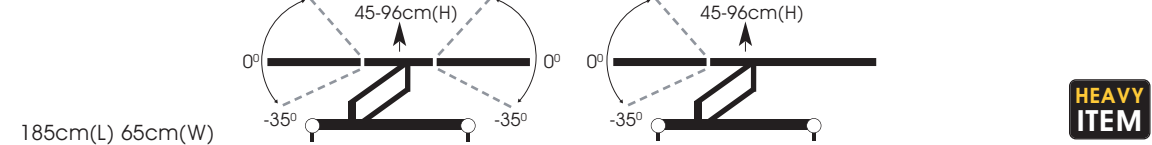

anti-bacterial vinyl upholstery colours - please specify when ordering

please see inside back cover for full specification of our vinyl range



Fusion Classic Plus+ 2 & 3 Section Fully Powered Electric Couches

The new Fusion Classic Plus+ extends our already popular Fusion range, providing enhanced user functionality and easier patient positioning through its fully powered height, head and foot sections. Fusion Classic Plus+ is simply, strong, stable, aesthetically pleasing and easy to clean.



Fully powered height adjustment



Fully powered head section



Fully powered foot section



Code: **Sun-FVHC+3E**
Fusion Classic Plus+ 3 Section Electric Couch with powered height, head & foot section (Shown with optional accessories)



Code: **Sun-FVHC+2E**
Fusion Classic Plus+ 2 Section Electric Couch with powered height & head section



3 year warranty on all moving components



Lifetime warranty on frame



Normally delivered within 7-10 working days (*UK Only)

product information

 Electric or Hydraulic height adjustment 45-96cm	 225kg Maximum user weight (35st.)	 Gas strut assisted multi-position head and foot sections	 Back rest and leg rest adjustment +70° / -35°	 Easy to use handset (Electric models only)
 Retractable positioning castors	 Adjustable height levelling foot	 Fully upholstered head & foot sections	 Double layer density foam for support & comfort	 Luxury 65mm deep contoured upholstery
 Anti-bacterial/anti-microbial vinyl	 Paper roll holder (supplied as standard)	 Easy clean design and materials	 Anti-bacterial Vinyl Strength Test BS EN ISO 13934-1: 2013 BS EN ISO 13973-3: 2000 BS EN ISO 12947-2: 1998	 Anti-bacterial Vinyl Fire (Flammability) Testing BS 5852 : 2006 Clause 11 (composites)

accessories

* these accessories can only be fitted when ordered with the couch

 Sun-FVHC/LEG1 Leg Supports	 Sun-FVHC/PHB1 Phlebotomy Arm (each)	 Sun-FVHC/FSW1* Foot Switch	 Sun-FVHC/SUP1 Gynae Stirrups	 Sun-CHP1 Head Pillow
 Sun-FVHC/CBH1* Breathing Hole	 Sun-FVHC/CSR* Folding Side Rails (pair)	 Sun-FVHC/IV2* IV Pole Attachment	 Sun-FVHC/RAIL* Medi-Rail Attachment	 Sun-FVHC/BB* Battery Backup
 Sun-FVHC/HEO* Electrically Operated Head Section Upgrade	 Sun-FVHC/FEO* Electrically Operated Foot Section Upgrade	 Sun-INST1* Installation Service & Packaging Recycling	 Sun-DISPOSAL1** Removal & Disposal of Old Couch	** Removal from ground floor only - weight & removal restrictions apply, please enquire

dimensions

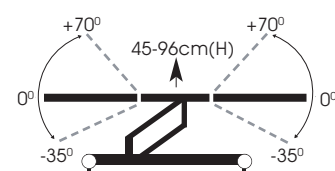

185cm(L) 65cm(W)

HEAVY ITEM

anti-bacterial vinyl upholstery colours - please specify when ordering

please see inside back cover for full specification of our vinyl range



The new generation of Fusion Classic has been designed to assist in making treatment procedures even easier and more efficient than ever. Fusion Classic is simply, strong, stable, aesthetically pleasing and easy to clean.



Fully upholstered head & foot sections with gas assisted adjustment

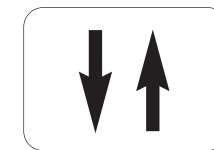

Electric or Hydraulic height adjustment



Increased maximum user weight to 225kg



Optional Electric Head & Foot Sections (electric models only)



Code: Sun-FVHC3E
Fusion Classic 3 Section Electric Couch (Shown with optional accessories)



3 year warranty on all moving components



Normally delivered within 7-10 working days (*UK Only)



Lifetime warranty on frame



Hydraulic height adjustment

Code: Sun-FVHC3H
Fusion Classic 3 Section Hydraulic Couch (Shown with optional pillow)

product information

 Electric or Hydraulic height adjustment 45-96cm	 225kg Maximum user weight (35st.)	 Gas strut assisted multi-position head and foot sections	 Back rest and leg rest adjustment +70° / -35°	 Easy to use handset (Electric models only)
 Retractable positioning castors	 Adjustable height levelling foot	 Fully upholstered head & foot sections	 Double layer density foam for support & comfort	 Luxury 65mm deep contoured upholstery
 Anti-bacterial/anti-microbial vinyl	 Paper roll holder (supplied as standard)	 Easy clean design and materials	 FIRA Independently tested by FIRA	 Anti-bacterial Vinyl
		 Anti-bacterial Vinyl Strength Test BS EN ISO 13934-1: 2013 BS EN ISO 13973-3: 2000 BS EN ISO 12947-2: 1998	 Fire (Flammability) Testing Flammability BS 7176 Medium Hazard BS 5852 : 2006 Clause 11 (composites)	

accessories

* these accessories can only be fitted when ordered with the couch

 Sun-FVHC/LEG1 Leg Supports	 Sun-FVHC/PHB1 Phlebotomy Arm (each)	 Sun-FVHC/FSW1* Foot Switch	 Sun-FVHC/SUP1 Gynae Stirrups	 Sun-CHP1 Head Pillow
 Sun-FVHC/CBH1* Breathing Hole	 Sun-FVHC/CSR* Folding Side Rails (pair)	 Sun-FVHC/IV2* IV Pole Attachment	 Sun-FVHC/RAIL* Medi-Rail Attachment	 Sun-FVHC/BB* Battery Backup
 Sun-FVHC/HEO* Electrically Operated Head Section Upgrade	 Sun-INST1* Installation Service & Packaging Recycling	 Sun-DISPOSAL1** Removal & Disposal of Old Couch	** Removal from ground floor only - weight & removal restrictions apply, please enquire	

dimensions

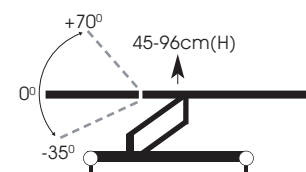

185cm(L) 65cm(W)

HEAVY ITEM

anti-bacterial vinyl upholstery colours - please specify when ordering

please see inside back cover for full specification of our vinyl range



The new generation of Fusion Classic has been designed to assist in making treatment procedures even easier and more efficient than ever. Fusion Classic is simply, strong, stable, aesthetically pleasing and easy to clean.



Fully upholstered head section with gas assisted adjustment

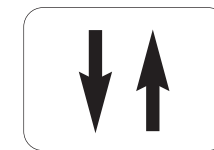

Electric or Hydraulic height adjustment



Increased maximum user weight to 225kg



Optional Electric Head Section (electric models only)



Code: Sun-FVHC2E
Fusion Classic 2 Section Electric Couch



3 year warranty on all moving components



Normally delivered within 7-10 working days (*UK Only)



Lifetime warranty on frame



Code: Sun-FVHC2H
Fusion Classic 2 Section Hydraulic Couch



Hydraulic height adjustment



product information

 Electric or Hydraulic height adjustment 45-96cm	 Maximum user weight (40st.) 250kg	 Gas strut assisted multi-position head and foot sections	 Back rest and leg rest adjustment +70° / -35°	 Easy to use handset (Electric models only)
 Retractable positioning castors	 Adjustable height levelling foot	 Fully upholstered head & foot sections	 Double layer density foam for support & comfort	 Luxury 65mm deep contoured upholstery
 Anti-bacterial/anti-microbial vinyl	 Paper roll holder (supplied as standard)	 Easy clean design and materials	 Anti-bacterial Vinyl Strength Test BS EN ISO 13934-1: 2013 BS EN ISO 13973-3: 2000 BS EN ISO 12947-2: 1998	 Fire (Flammability) Testing Flammability BS 7176 Medium Hazard BS 5852 : 2006 Clause 11 (composites)
 Anti-bacterial Vinyl				

accessories * these accessories can only be fitted when ordered with the couch

 Sun-FECO/LEG1 Leg Supports	 Sun-FECO/PHB1 Phlebotomy Arm (each)	 Sun-FECO/FSW1* Foot Switch	 Sun-FECO/SUP1 Gynae Stirrups	 Sun-CHP1 Head Pillow
 Sun-FECO/CBH1* Breathing Hole	 Sun-FECO/CSR* Folding Side Rails (pair)	 Sun-FECO/IV2* IV Pole Attachment	 Sun-FECO/RAIL* Medi-Rail Attachment	 Sun-FECO/BB* Battery Backup
 Sun-FECO/HEO* Electrically Operated Head Section Upgrade	 Sun-FECO/FEO* Electrically Operated Foot Section Upgrade	 Sun-INST1* Installation Service & Packaging Recycling	 Sun-DISPOSAL1** Removal & Disposal of Old Couch	** Removal from ground floor only - weight & removal restrictions apply, please enquire

dimensions

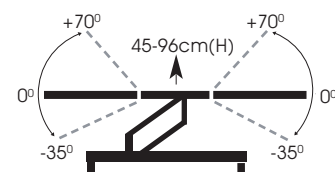

185cm(L) 65cm(W)



anti-bacterial vinyl upholstery colours - please specify when ordering

please see inside back cover for full specification of our vinyl range



The new Fusion Eco couch range provides most of the functionality you would expect for our standard Fusion range at a more affordable price to suit individual budgets. Fusion Eco is simply, strong, stable, aesthetically pleasing and easy to clean.



Fully upholstered head & foot sections with gas assisted adjustment

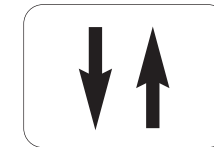

Electric or Hydraulic height adjustment



Increased maximum user weight to 250kg



Optional
Electric Head & Foot Sections
(electric models only)



Code: **Sun-FECO3E**
Fusion Eco 3 Section Electric Couch (Shown with optional accessories)



3 year warranty on all moving components



Normally delivered within 7-10 working days (*UK Only)



Lifetime warranty on frame



Code: **Sun-FECO3H**
Fusion Eco 3 Section Hydraulic Couch















Hydraulic height adjustment

product information

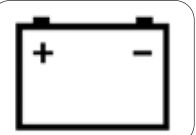
 Electric or Hydraulic height adjustment 45-96cm	 Maximum user weight (40st.) 250kg	 Gas strut assisted multi-position head and foot sections	 Back rest and leg rest adjustment +70° / -35°	 Easy to use handset (Electric models only)
 Retractable positioning castors	 Adjustable height levelling foot	 Fully upholstered head & foot sections	 Double layer density foam for support & comfort	 Luxury 65mm deep contoured upholstery
 Anti-bacterial/anti-microbial vinyl	 Paper roll holder (supplied as standard)	 Easy clean design and materials	 Anti-bacterial Vinyl Strength Test BS EN ISO 13934-1: 2013 BS EN ISO 13973-3: 2000 BS EN ISO 12947-2: 1998	 Fire (Flammability) Testing BS 5852 : 2006 Clause 11 (composites)

accessories * these accessories can only be fitted when ordered with the couch

 Sun-FECO/LEG1 Leg Supports	 Sun-FECO/PHB1 Phlebotomy Arm (each)	 Sun-FECO/FSW1* Foot Switch	 Sun-FECO/SUP1 Gynae Stirrups	 Sun-CHP1 Head Pillow
 Sun-FECO/CBH1* Breathing Hole	 Sun-FECO/CSR* Folding Side Rails (pair)	 Sun-FECO/IV2* IV Pole Attachment	 Sun-FECO/RAIL* Medi-Rail Attachment	 Sun-FECO/BB* Battery Backup
 Sun-FECO/HEO* Electrically Operated Head Section Upgrade	 Sun-INST1* Installation Service & Packaging Recycling	 Sun-DISPOSAL1** Removal & Disposal of Old Couch	** Removal from ground floor only - weight & removal restrictions apply, please enquire	

dimensions

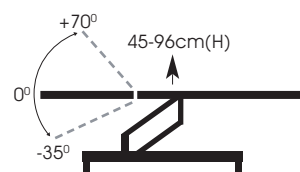

185cm(L) 65cm(W)

HEAVY ITEM

anti-bacterial vinyl upholstery colours - please specify when ordering

please see inside back cover for full specification of our vinyl range



black grey beige primrose walnut red wine salmon lilac navy mid blue sky blue cool blue green mint white

The new Fusion Eco couch range provides most of the functionality you would expect for our standard Fusion range at a more affordable price to suit individual budgets. Fusion Eco is simply, strong, stable, aesthetically pleasing and easy to clean.



Fully upholstered head section with gas assisted adjustment

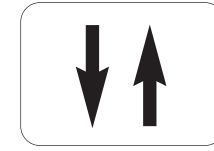

Electric or Hydraulic height adjustment



Increased maximum user weight to 250kg



Optional Electric Head Section (electric models only)



Code: Sun-FECO2E
Fusion Eco 2 Section Electric Couch (Shown with optional accessories)



3 year warranty on all moving components



Normally delivered within 7-10 working days (*UK Only)



Lifetime warranty on frame



Code: Sun-FECO2H
Fusion Eco 2 Section Hydraulic Couch



Hydraulic height adjustment



product information

Electric or Hydraulic height adjustment 45-98cm	Maximum user weight (35st.) 225kg	Gas assisted back (-20 - +80°)	Easy to use handset (Electric models only)	Rear retractable positioning castors
100mm Front braked castors	Cut away lithotomy section for easier access	100mm Deep stainless steel operators tray	Fully adjustable leg supports	Fold down arms for patient comfort & security
Double layer density foam for support & comfort	Anti-bacterial/anti-microbial vinyl	Easy clean design and materials	Anti-bacterial Vinyl Strength Test BS EN ISO 13934-1: 2013 BS EN ISO 13973-3: 2000 BS EN ISO 12947-2: 1998	Fire (Flammability) Testing Flammability BS 7176 Medium Hazard BS 5852: 2006 Clause 11 (composites)

accessories

* these accessories can only be fitted when ordered with the couch

Sun-FGYN/FSW1* Foot Switch (For Gynae 1)	Sun-FGYN/CHP1 Head Pillow	Sun-FGYN/CBH1* Breathing Hole	Sun-FGYN/IV2* IV Pole Attachment	Sun-FGYN/SUP1 Stirrups (pair)
Sun-FGYN/FS Detachable Foot Section Extension	Sun-FGYN/WB Wall Bracket for Foot Section	Sun-FGYN/BB* Battery Backup	Sun-INST1* Installation Service & Packaging Recycling	Sun-DISPOSAL1/** Removal & Disposal of Old Couch

** Removal from ground floor only - weight and removal restrictions apply, please enquire

dimensions

137cm(L) 65cm(W)
187cm with foot extension

45-98cm(H)
-20 - +80°

Detachable Foot Section Extension
50cm(L) 65cm(W)

HEAVY ITEM

anti-bacterial vinyl upholstery colours - please specify when ordering

please see inside back cover for full specification of our vinyl range

black	grey	beige	primrose	walnut	red wine	salmon	lilac	navy	mid blue	sky blue	cool blue	green	mint	white

The new Gynae couch range features an ergonomic design providing comfort for the patient and ease of access and patient positioning for the clinician. Fusion Gynae is simply, strong, stable, aesthetically pleasing and easy to clean.



Code: **Sun-FGYNE1**
Fusion Gynae1 - 2 section couch
Electric powered height, gas assisted back, no seat tilt with arm supports & leg supports



3 year warranty on all moving components



Lifetime warranty on frame



Normally delivered within 7-10 working days (*UK Only)



Code: **Sun-FGYNH1**
Fusion Gynae1 - 2 section couch
Hydraulic powered height, gas assisted back, no seat tilt with arm supports & leg supports



Hydraulic height adjustment

product information

 Electric height adjustment 45-98cm	 225kg Maximum user weight (35st.)	 Electric Powered Tilting Seat 0 to -15° (Trendelenburg)	 Fully powered head section (Sun-FGYNE3)	 Easy to use handset
 Rear retractable positioning castors	 100mm Front braked castors	 Cut away lithotomy section for easier access	 100mm Deep stainless steel operators tray	 Fully adjustable leg supports
 Fold down arms for patient comfort & security	 Double layer density foam for support & comfort	 Easy clean design and materials	 Independently tested by FIRA	 Anti-bacterial Vinyl
		Anti-bacterial Vinyl Strength Test BS EN ISO 13934-1: 2013 BS EN ISO 13973-3: 2000 BS EN ISO 12947-2: 1998		Fire (Flammability) Testing BS 5852: 2006 Clause 11 (composites)

accessories

* these accessories can only be fitted when ordered with the couch

 Sun-FGYN/FSW2* Foot Switch (Gynae 2)	 Sun-FGYN/FSW3* Foot Switch (Gynae 3)	 Sun-FGYN/CHP1 Head Pillow	 Sun-FGYN/CBH1* Breathing Hole	 Sun-FGYN/IV2* IV Pole Attachment
 Sun-FGYN/SUP1 Stirrups (pair)	 Sun-FGYN/FS Detachable Foot Section Extension	 Sun-FGYN/WB Wall Bracket for Foot Section	 Sun-FGYN/BB* Battery Backup	 Sun-INST1* Installation Service & Packaging Recycling
 Sun-DISPOSAL1** Removal & Disposal of Old Couch	** Removal from ground floor only - weight & removal restrictions apply, please enquire			

dimensions

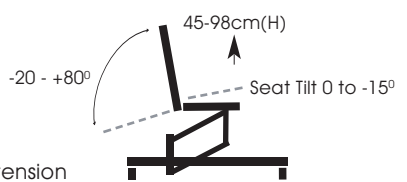

137cm(L) 65cm(W)
187cm with foot extension

45-98cm(H)
-20 - +80°
Seat Tilt 0 to -15°

Detachable Foot Section Extension
50cm(L) 65cm(W)

HEAVY ITEM

anti-bacterial vinyl upholstery colours - please specify when ordering

please see inside back cover for full specification of our vinyl range

														
black	grey	beige	primrose	walnut	red wine	salmon	lavender	navy	mid blue	sky blue	cool blue	green	mint	white

The new Gynae couch range features an ergonomic design providing comfort for the patient and ease of access and patient positioning for the clinician. Fusion Gynae is simply, strong, stable, aesthetically pleasing and easy to clean.



Code: **Sun-FGYNE2**
Fusion Gynae2 - 2 section couch
Electric powered height, gas assisted back,
powered tilting seat with arm supports & leg supports



3 year warranty on all moving components



Lifetime warranty on frame



Normally delivered within 7-10 working days (*UK Only)











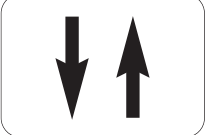



Code: **Sun-FGYNE3**
Fusion Gynae3 - 2 section couch
Electric powered height, back and tilting seat
with arm supports & leg supports

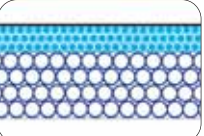

Fusion Drop End Multi-Discipline Couch

product information

 Electric or Hydraulic height adjustment	 Maximum user weight (40st.)	 Optional breathing hole & plug in foot section for physio use	 50mm Retractable positioning castors	 Adjustable height levelling foot
 Gas assisted head & foot sections as standard	 Electric head/foot section adjustment (Sun-FDECE2)	 Tilting Seat for Trendelenburg (Sun-FDECE2)	 Hoist clearance 13cm	 Range of additional accessories for flexibility
 Fully upholstered head & foot sections	 Double layer density foam for support & comfort	 Luxury 65mm deep contoured upholstery	 Anti-bacterial/anti-microbial vinyl	 Paper roll holder (supplied as standard)
 Easy clean design and materials	 Anti-bacterial Vinyl Strength Test BS EN ISO 13934-1: 2013 BS EN ISO 13973-3: 2000 BS EN ISO 12947-2: 1998	 Fire (Flammability) Testing Flammability BS 7176 Medium Hazard BS 5852 : 2006 Clause 11 (composites)		

accessories * these accessories can only be fitted when ordered with the couch

 Sun-CHP1 Head Pillow	 Sun-FDEC/CBH2* Breathing Hole - in foot section	 Sun-FDEC/LEG1 Leg Supports (pair)	 Sun-FDEC/PHB1 Phlebotomy Arm (pair)	 Sun-FDEC/PAS1 Padded Arm Supports (pair)
 Sun-FDEC/SUP1 Stirrups (pair)	 Sun-FDEC/CSR* Folding Side Rails (pair)	 Sun-FDEC/IV2* IV Pole Attachment	 Sun-FDEC/FSW1* Foot Switch	 Sun-DISPOSAL1** Removal & Disposal of Old Couch

** Removal from ground floor only - weight and removal restrictions apply, please enquire

dimensions

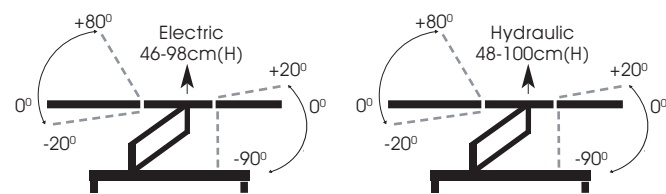

170cm(L) 65cm(W)

HEAVY ITEM

anti-bacterial vinyl upholstery colours - please specify when ordering

please see inside back cover for full specification of our vinyl range

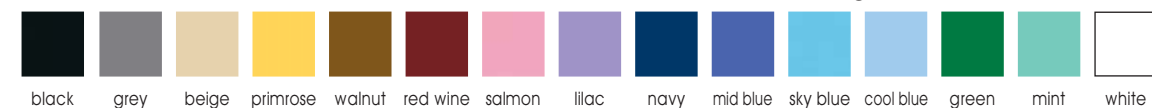

Fusion Drop End Multi-Discipline Couch

The new Fusion Drop End Couch range has been designed using our extensive knowledge to provide a trusted, ergonomic design providing comfort for the patient, ease of access via the drop end design and comfortable patient positioning for the clinician. The couch offers amazing flexibility and can be configured into a wide range of specialist treatment uses including physio, gynae, phlebotomy or treatment chair via the addition of relevant accessories.



Code: **Sun-FDECE2**
Fusion Drop End Multi-Discipline Couch
Electric Height Adjustment
Electric back and foot sections



Code: **Sun-FDECE1**
Fusion Drop End Multi-Discipline Couch
Electric Height Adjustment
Gas assisted head and foot sections

3 year warranty on all moving components

Lifetime warranty on frame





Normally delivered within 7-10 working days (*UK Only)

FSC
www.fsc.org
FSC® C123851
The mark of responsible forestry

Code: **Sun-FDECH1**
Fusion Drop End Multi-Discipline Couch
Hydraulic Height Adjustment
Gas assisted head and foot sections



Hydraulic height adjustment

product information

Electric or Hydraulic height adjustment	Maximum user weight (40st.) 250kg	50mm Retractable positioning castors	Gas assisted head and split foot sections	Electric head section adjustment (Sun-FPODE2)
Adjustable leg length extension upto 15cm	Tilting Seat for Trendelenburg (Sun-FPODE1 & Sun-FPODE2) -20° TRENDELEBURG	Stay level swing back padded arm rests for easy patient access	Adjustable height levelling foot	Hoist clearance 13cm
Fully upholstered head & foot sections	Double layer density foam for support & comfort	Luxury 65mm deep contoured upholstery	Anti-bacterial/anti-microbial vinyl	Paper roll holder (supplied as standard)
Easy clean design and materials	Anti-bacterial Vinyl Strength Test BS EN ISO 13934-1: 2013 BS EN ISO 13973-3: 2000 BS EN ISO 12947-2: 1998	Fire (Flammability) Testing Flammability BS 7176 Medium Hazard BS 5852 : 2006 Clause 11 (composites)	Anti-bacterial Vinyl	

accessories

* these accessories can only be fitted when ordered with the couch

Sun-CHP1 Head Pillow	Sun-FPOD/IV2* IV Pole Attachment	Sun-FPOD/FSW1* Foot Switch (FPODE1)	Sun-FPOD/FSW2* Foot Switch (FPODE2)	Sun-FPOD/FSW2* Foot Switch (FPODE2)	installation
	** Removal from ground floor only - weight & removal restrictions apply, please enquire				
Sun-DISPOSAL1/** Removal & Disposal of Old Couch					

dimensions

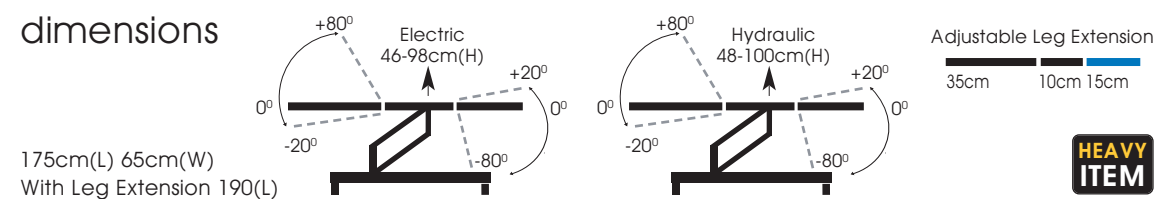

anti-bacterial vinyl upholstery colours - please specify when ordering

please see inside back cover for full specification of our vinyl range

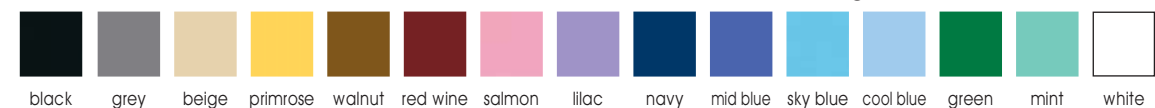

The new Fusion Podiatry Chair range has been designed using our extensive knowledge to provide a trusted, ergonomic design providing comfort for the patient, ease of access via the split leg design, Trendelenburg movement as standard on electric models and comfortable patient positioning for the clinician.



Code: **Sun-FPODE1**
Fusion Podiatry Chair
Electric Height Adjustment
Gas assisted head and split adjustable length foot sections
(Powered Trendelenburg -20° Movement)

Code: **Sun-FPODE2** (shown above)
Fusion Podiatry Chair
Electric Height Adjustment
Electric head and split adjustable length foot sections
(Powered Trendelenburg -20° Movement)



7-10 DAYS DELIVERY*

Normally delivered within 7-10 working days (*UK Only)

Code: **Sun-FPODH1**
Fusion Podiatry Chair
Hydraulic Height Adjustment
Gas assisted head and split adjustable length foot sections
(No Trendelenburg Movement)



Hydraulic height adjustment



3 year warranty on all moving components





Lifetime warranty on frame



product information

 Powered tilting seat Sun-FTRTE2/3/5/6 only	 -20° TRENDELEBURG Tilting Seat for Trendelenburg Sun-FTRTE2/3/5/6 only	 Head adjustment +80° / -20°	 Adjustable foot section +20° / -90°	 2 Adjustable/removable padded arm supports
 250kg Maximum user weight (40st.)	 Easy to use handset	 50mm Retractable positioning castors	 Adjustable height levelling foot	 Dual sided foot pedals (Hydraulic models only)
 Hoist clearance 13cm	 Fully upholstered head & foot sections	 Double layer density foam for support & comfort	 Luxury 65mm deep contoured upholstery	 Anti-bacterial/ anti-microbial vinyl
 Paper roll holder (supplied as standard)	 Easy clean design and materials	 Independently tested by FIRA Anti-bacterial Vinyl Strength Test BS EN ISO 13934-1: 2013 BS EN ISO 13973-3: 2000 BS EN ISO 12947-2: 1998	 West Yorkshire Materials Testing Service Anti-bacterial Vinyl Fire (Flammability) Testing Flammability BS 7176 Medium Hazard BS 5852 : 2006 Clause 11 (composites)	

accessories * these accessories can only be fitted when ordered with the couch

 Sun-FTRT/PHB1 Phlebotomy Arm (pair)	 Sun-CHP1 Head Pillow	 Sun-FTRT/CBH1* Breathing Hole - in foot section (Sun-FTRTE1,2,3 & Sun-FTRTH1 only)	 Sun-FTRT/FSW1* Foot Switch (Sun-FTRTE1 & 4)	 Sun-FTRT/FSW2* Foot Switch 2 Section (Sun-FTRTE2 & 5)
 Sun-FTRT/FSW3* Foot Switch 3 Section (Sun-FTRTE3 & 6)	 Sun-FTRT/IV2* IV Pole Attachment	 Sun-INST1* Installation Service & Packaging Recycling	 Sun-DISPOSAL1** Removal & Disposal of Old Couch	** Removal from ground floor only - weight & removal restrictions apply, please enquire

dimensions

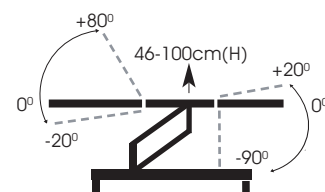

170cm(L) 65cm(W)

**HEAVY
ITEM**

anti-bacterial vinyl upholstery colours - please specify when ordering

please see inside back cover for full specification of our vinyl range



The new Fusion Treatment Chair range has been designed using our extensive knowledge to provide a trusted, ergonomic design providing comfort for the patient, ease of access via the split leg design and comfortable patient positioning for the clinician.



Powered tilting seat



Adjustable foot section



Recovery position



Code: **Sun-FTRTE3**
Fusion Treatment Chair - Electric Height Single Foot Section
Powered head section and powered tilting seat

Electric Height Single Foot Section

Code: **Sun-FTRTE1** - Gas assisted head section and fixed seat
Code: **Sun-FTRTE2** - Gas assisted head section and powered tilting seat
Code: **Sun-FTRTE3** - Powered head section and powered tilting seat

Electric Height Split Foot Section

Code: **Sun-FTRTE4** - Gas assisted head section and fixed seat
Code: **Sun-FTRTE5** - Gas assisted head section and powered tilting seat
Code: **Sun-FTRTE6** - Powered head section and powered tilting seat

Hydraulic Height Adjustment with Fixed Seat

Code: **Sun-FTRTH1** - Gas assisted head section and single foot section
Code: **Sun-FTRTH4** - Gas assisted head section and split foot section



3 year warranty on all
moving components



Lifetime warranty
on frame



Normally delivered within
7-10 working days (*UK Only)



Code: **Sun-FTRTH4**
Fusion Treatment Chair - Hydraulic Height Adjustment Fixed Seat
Gas assisted head section and split foot section



Fixed Height Reclining Treatment Chairs

product information



50cm Fixed seat height



Maximum user weight (35st.)



50mm Locking castors for stability & easy movement (Sun-TREA2)



4 Adjustable feet (Sun-TREA1)



Split leg design with locking bars for leg positioning



2 Adjustable/removable padded arm supports



Luxury 60mm thick padded upholstery for comfort



Self locking gas assisted back rest section



Hoist clearance 13cm



Head and foot, up or down -10°/+10° for patient emergencies

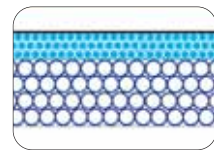

Double layer density foam for support & comfort



Anti-bacterial/anti-microbial vinyl



Paper roll holder (supplied as standard)



Easy clean design and materials



Anti-bacterial Vinyl Strength Test
BS EN ISO 13934-1: 2013
BS EN ISO 13973-3: 2000
BS EN ISO 12947-2: 1998



Fire (Flammability) Testing
Flammability BS 7176 Medium Hazard
BS 5852 : 2006 Clause 11 (composites)

accessories

* these accessories can only be fitted when ordered with the couch



Sun-TREA/PHB1
Phlebotomy Arm (each)



Sun-CHP1
Head Pillow

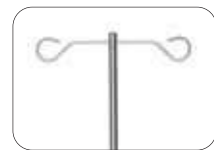

Sun-TREA/IV2*
IV Pole Attachment



Sun-INST1*
Installation Service & Packaging Recycling



Sun-DISPOSAL1**
Removal & Disposal of Old Couch

** Removal from ground floor only - weight and removal restrictions apply, please enquire

dimensions

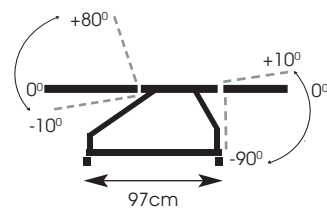

170cm(L) 65cm(W) 50cm(H)



anti-bacterial vinyl upholstery colours - please specify when ordering

please see inside back cover for full specification of our vinyl range



black grey beige primrose walnut red wine salmon lilac navy mid blue sky blue cool blue green mint white

Fixed Height Reclining Treatment Chairs

The new Fixed Height Reclining Treatment Chair range has been designed using our extensive knowledge to provide a trusted, ergonomic design providing comfort for the patient and comfortable patient positioning for the clinician. The chair features a robust locking bar and gas strut backrest arrangement allowing the patient to rapidly go from a seated position to head down, feet up position in only 3 movements. The split leg design with locking bars is easy to adjust and gives a wide range of positions.



Split leg design with locking bars for leg positioning



In emergency situations for patient recovery chair goes head down -10° and foot up +10°



Code: Sun-TREA2
Fixed Height Treatment Chair - with 4 locking castors



Code: Sun-TREA1
Fixed Height Treatment Chair - with adjustable feet



2 year warranty on all moving components





Normally delivered within 7-10 working days (*UK Only)



Code: Sun-TREA1
Fixed Height Treatment Chair - with adjustable feet

product information

 Electric or Hydraulic height adjustment	 Maximum user weight (40st.)	 Gas assisted head & foot sections	 Electric head section & foot sections adjustment option (Sun-FPHBE2 & 3)	 Tilting Seat for Trendelenburg (Sun-FPHBE3)
 Two fully adjustable phlebotomy arms as standard	 50mm Retractable positioning castors	 Adjustable height levelling foot	 Dual sided foot pedals (Hydraulic models only)	 Hoist clearance 13cm
 Fully upholstered head & foot sections	 Double layer density foam for support & comfort	 Luxury 65mm deep contoured upholstery	 Anti-bacterial/anti-microbial vinyl	 Paper roll holder (supplied as standard)
 Easy clean design and materials	 Anti-bacterial Vinyl Strength Test BS EN ISO 13934-1: 2013 BS EN ISO 13973-3: 2000 BS EN ISO 12947-2: 1998	 Fire (Flammability) Testing Flammability BS 7176 Medium Hazard BS 5852 : 2006 Clause 11 (composites)		

accessories

* these accessories can only be fitted when ordered with the couch

 Sun-CHP1 Head Pillow	 Sun-FPHB/FSW1* Foot Switch (Sun-FPHBE1)	 Sun-FPHB/FSW3* Foot Switch 3 Section (Sun-FPHBE2)	 Sun-FPHB/FSW4* Foot Switch 4 Section (Sun-FPHBE3)	 Sun-FPHB/IV2* IV Pole Attachment
 Sun-INST1* Installation Service & Packaging Recycling	 Sun-DISPOSAL1** Removal & Disposal of Old Couch	** Removal from ground floor only - weight & removal restrictions apply, please enquire		

dimensions

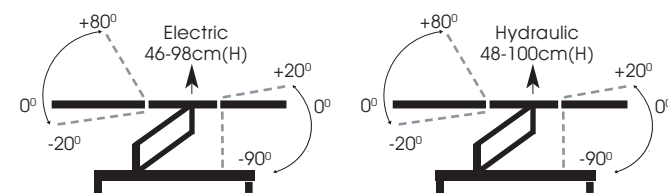

170cm(L) 65cm(W)

HEAVY ITEM

anti-bacterial vinyl upholstery colours - please specify when ordering

please see inside back cover for full specification of our vinyl range

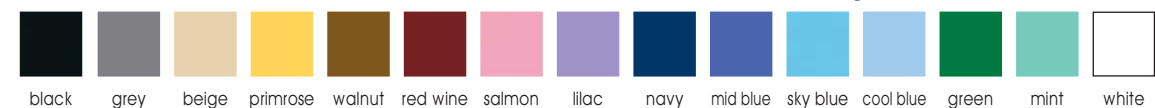

The new Fusion Phlebotomy Chair range has been designed using our extensive knowledge to provide a trusted, ergonomic design providing comfort for the patient and comfortable patient positioning for the clinician.



Easy removal of the phlebotomy arms allows the chair to be used as a standard drop end couch



In emergency situations the chair goes head down and feet up for patient recovery



Code: **Sun-FPHBE3**
Fusion Phlebotomy Chair - Electric Height Adjustment
Electric back and foot sections and tilting seat

Electric Height Adjustment

Code: **Sun-FPHBE1** - Electric Height Adjustment gas assisted head and foot sections
Code: **Sun-FPHBE2** - Electric Height Adjustment electric back and foot sections
Code: **Sun-FPHBE3** - Electric back and foot sections and tilting seat



3 year warranty on all moving components



Lifetime warranty on frame













Normally delivered within 7-10 working days (*UK Only)



Code: **Sun-FPHBH1**
Fusion Phlebotomy Chair - Hydraulic Height Adjustment
Gas assisted head and foot sections

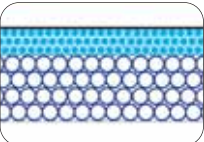

product information

 50cm Fixed height seat	 Maximum user weight (35st.)	 50mm Locking castors for stability & easy movement (PHLEB2)	 4 Adjustable feet (PHLEB1)	 Optional padded arm supports
 Luxury 60mm thick padded upholstery for comfort	 Self locking gas assisted back section adjustment	 Hoist clearance 13cm	 Head and foot, up or down -10°/+10° for patient emergencies	 One fully adjustable phlebotomy arm as standard (can be used either side)
 Double layer density foam for support & comfort	 Anti-bacterial/anti-microbial vinyl	 Paper roll holder (supplied as standard)	 Easy clean design and materials	 Anti-bacterial Vinyl Strength Test BS EN ISO 13934-1: 2013 BS EN ISO 13973-3: 2000 BS EN ISO 12947-2: 1998

West Yorkshire Materials Testing Service
Anti-bacterial Vinyl
Fire (Flammability) Testing
Flammability BS 7176 Medium Hazard
BS 5852 : 2006 Clause 11 (composites)

accessories

* these accessories can only be fitted when ordered with the couch

 Sun-PHLEB/PHB1 Additional Phlebotomy Arm (each)	 Sun-CHP1 Head Pillow	 Sun-PHLEB/IV2* IV Pole Attachment	 Sun-PHLEB/PAS1 Padded Arm Supports (each)	 Sun-INST1* Installation Service & Packaging Recycling
---	--	---	---	---



** Removal from ground floor only - weight & removal restrictions apply, please enquire

Sun-DISPOSAL1**
Removal & Disposal of Old Couch

dimensions

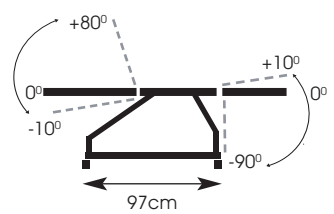

170cm(L) 65cm(W) 50cm(H)



anti-bacterial vinyl upholstery colours - please specify when ordering

please see inside back cover for full specification of our vinyl range



The new Fixed Height Reclining Treatment Chair range has been designed using our extensive knowledge to provide a trusted, ergonomic design providing comfort for the patient and comfortable patient positioning for the clinician. The chair features a robust locking bar and gas strut backrest arrangement allowing the patient to rapidly go from a seated position to head down, feet up position in only 2 movements. The leg section with locking bars is easy to adjust and gives a wide range of positions.



In emergency situations for patient recovery chair goes head down -10° and foot up +10°



Code: Sun-PHLEB1
Fixed Height Phlebotomy Chair - with adjustable feet



Code: Sun-PHLEB2
Fixed Height Phlebotomy Chair - with 4 locking castors



2 year warranty on all moving components











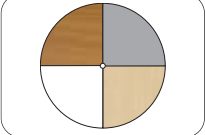





Normally delivered within 7-10 working days (*UK Only)



Code: Sun-PHLEB2
Fixed Height Phlebotomy Chair - with 4 locking castors

product information

 4 Cabinet finishes	 Maximum user weight (26st.)	 Multi-position self locking backrest	 Luxury 65mm deep contoured upholstery	 Anti-bacterial/anti-microbial vinyl
 Paper roll holder (supplied as standard)	 2 Pull-out work surfaces	 Cupboards include pull-out work surface & basket, shelf and lock	 Locking doors supplied with 2 keys	 Durable silver epoxy coated frame
 Cabinets supplied fully assembled	 Easy clean design and materials	 Anti-bacterial Vinyl Strength Test BS EN ISO 13934-1: 2013 BS EN ISO 13973-3: 2000 BS EN ISO 12947-2: 1998	 Anti-bacterial Vinyl Fire (Flammability) Testing Flammability BS 7176 Medium Hazard BS 5852 : 2006 Clause 11 (composites)	 Independently tested by FIRA FIRA Standard 6250 2005 Specification: Adhesion Performance General/Severe

accessories

* these accessories can only be fitted when ordered with the couch

 Sun-CBH1* Breathing Hole	 Sun-CHP1 Head Pillow	 Sun-CDT1 Drawer Insert (each)	 Sun-LEG1* Leg Supports	 Sun-UPH1* Special Upholstery Colour
 Sun-INST1* Installation Service & Packaging Recycling	 Sun-DISPOSAL1*/** Removal & Disposal of Old Couch	 Sun-STP1 Single Tier Step (oval)	 Sun-STP2 Double Tier Step (oval)	 Sun-STP3 Single Tier Step (rectangular)

** Removal from ground floor only - weight and removal restrictions apply, please enquire

dimensions

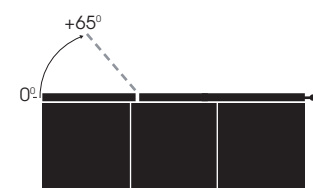

83cm(H) 193cm(L) 60cm(W)
with paper roll holder

HEAVY ITEM

anti-bacterial vinyl upholstery colours - please specify when ordering

please see inside back cover for full specification of our vinyl range



Specialist 2 Section Treatment Couch Systems

Combining functionality with storage and comfort, Specialist Couches assist in making examination and treatment procedures easier and more efficient.



Code: **Sun-CS1**
Specialist treatment couch system with 2 drawerline units, 1 drawer pack, 2 section upholstery with optional head pillow and leg supports



White (high gloss) cabinet finish



Titanium (high gloss) cabinet finish













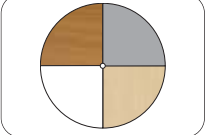



Beech effect cabinet finish



Maple effect cabinet finish



product information

 4 Cabinet finishes	 165kg Maximum user weight (26st.)	 Multi-position self locking backrest	 Luxury 65mm deep contoured upholstery	 Anti-bacterial/anti-microbial vinyl
 Paper roll holder (supplied as standard)	 2 Pull-out work surfaces	 Cupboards include pull-out work surface & basket, shelf and lock	 Locking doors supplied with 2 keys	 Durable silver epoxy coated frame
 Cabinets supplied fully assembled	 Easy clean design and materials	 Anti-bacterial Vinyl Strength Test BS EN ISO 13934-1: 2013 BS EN ISO 13973-3: 2000 BS EN ISO 12947-2: 1998	 Fire (Flammability) Testing Flammability BS 7176 Medium Hazard BS 5852 : 2006 Clause 11 (composites)	 FIRA Standard 6250 2005 Specification: Adhesion Performance General/Severe

accessories

* these accessories can only be fitted when ordered with the couch

 Sun-CBH1* Breathing Hole	 Sun-CHP1 Head Pillow	 Sun-CDT1 Drawer Insert (each)	 Sun-LEG1* Leg Supports	 Sun-UPH1* Special Upholstery Colour
 Sun-INST1* Installation Service & Packaging Recycling	 Sun-DISPOSAL1*/** Removal & Disposal of Old Couch	 Sun-STP1 Single Tier Step (oval)	 Sun-STP2 Double Tier Step (oval)	 Sun-STP3 Single Tier Step (rectangular)

** Removal from ground floor only - weight and removal restrictions apply, please enquire

dimensions

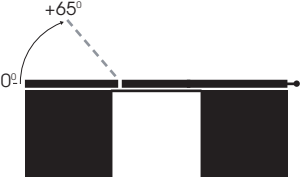

83cm(H) 193cm(L) 60cm(W)
with paper roll holder

HEAVY ITEM

anti-bacterial vinyl upholstery colours - please specify when ordering

please see inside back cover for full specification of our vinyl range

														
black	grey	beige	primrose	walnut	red wine	salmon	lilac	navy	mid blue	sky blue	cool blue	green	mint	white

Specialist 2 Section Treatment Couch Systems

Combining functionality with storage and comfort, Specialist Couches assist in making examination and treatment procedures easier and more efficient.



Code: **Sun-CS3**
Specialist treatment couch system with 1 drawerline unit, 1 drawer pack, 2 section upholstery with optional head pillow and leg supports



White (high gloss) cabinet finish

Titanium (high gloss) cabinet finish











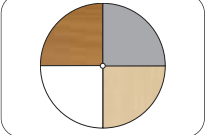





Beech effect cabinet finish

Maple effect cabinet finish



product information

 4 Cabinet finishes	 Maximum user weight (26st.)	 Multi-position self locking backrest	 Luxury 65mm deep contoured upholstery	 Anti-bacterial/anti-microbial vinyl
 Paper roll holder (supplied as standard)	 2 Pull-out work surfaces	 Cupboards include pull-out work surface & basket, shelf and lock	 Locking doors supplied with 2 keys	 Durable silver epoxy coated frame
 Cabinets supplied fully assembled	 Easy clean design and materials	 Anti-bacterial Vinyl Strength Test BS EN ISO 13934-1: 2013 BS EN ISO 13973-3: 2000 BS EN ISO 12947-2: 1998	 Fire (Flammability) Testing Flammability BS 7176 Medium Hazard BS 5852 : 2006 Clause 11 (composites)	 FIRA Standard 6250 2005 Specification: Adhesion Performance General/Severe

accessories

* these accessories can only be fitted when ordered with the couch

 Sun-CBH1* Breathing Hole	 Sun-CHP1 Head Pillow	 Sun-CDT1 Drawer Insert (each)	 Sun-LEG1* Leg Supports	 Sun-UPH1* Special Upholstery Colour
 Sun-INST1* Installation Service & Packaging Recycling	 Sun-DISPOSAL1** Removal & Disposal of Old Couch	 Sun-STP1 Single Tier Step (oval)	 Sun-STP2 Double Tier Step (oval)	 Sun-STP3 Single Tier Step (rectangular)

** Removal from ground floor only - weight and removal restrictions apply, please enquire

dimensions

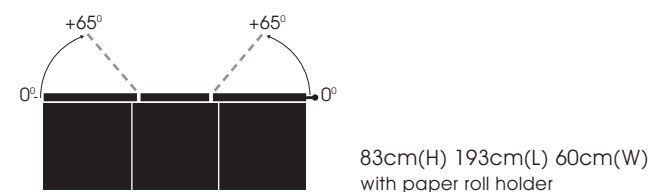

HEAVY ITEM

anti-bacterial vinyl upholstery colours - please specify when ordering

please see inside back cover for full specification of our vinyl range



Specialist 3 Section Treatment Couch Systems

Combining functionality with storage and comfort, Specialist Couches assist in making examination and treatment procedures easier and more efficient.



Code: **Sun-CS1/3S**
Specialist treatment couch system with 2 drawerline units, 1 drawer pack, 3 section upholstery with optional head pillow



White (high gloss) cabinet finish



Titanium (high gloss) cabinet finish













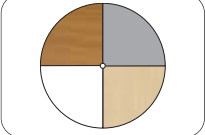



Beech effect cabinet finish



Maple effect cabinet finish



product information

 4 Cabinet finishes	 Maximum user weight (26st.)	 Multi-position self locking backrest	 Luxury 65mm deep contoured upholstery	 Anti-bacterial/anti-microbial vinyl
 Paper roll holder (supplied as standard)	 2 Pull-out work surfaces	 Cupboards include pull-out work surface & basket, shelf and lock	 Locking doors supplied with 2 keys	 Durable silver epoxy coated frame
 Cabinets supplied fully assembled	 Easy clean design and materials	 Anti-bacterial Vinyl Strength Test BS EN ISO 13934-1: 2013 BS EN ISO 13973-3: 2000 BS EN ISO 12947-2: 1998	 Fire (Flammability) Testing Flammability BS 7176 Medium Hazard BS 5852 : 2006 Clause 11 (composites)	 FIRA Standard 6250 2005 Specification: Adhesion Performance General/Severe

accessories

* these accessories can only be fitted when ordered with the couch

 Sun-CBH1* Breathing Hole	 Sun-CHP1 Head Pillow	 Sun-CDT1 Drawer Insert (each)	 Sun-LEG1* Leg Supports	 Sun-UPH1* Special Upholstery Colour
 Sun-INST1* Installation Service & Packaging Recycling	 Sun-DISPOSAL1** Removal & Disposal of Old Couch	 Sun-STP1 Single Tier Step (oval)	 Sun-STP2 Double Tier Step (oval)	 Sun-STP3 Single Tier Step (rectangular)

** Removal from ground floor only - weight and removal restrictions apply, please enquire

dimensions

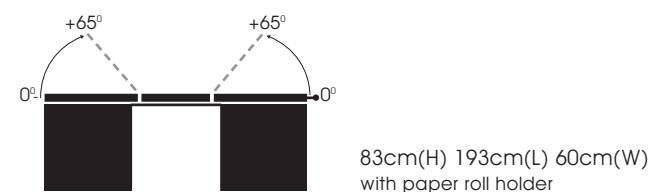

HEAVY ITEM

anti-bacterial vinyl upholstery colours - please specify when ordering

please see inside back cover for full specification of our vinyl range



Specialist 3 Section Treatment Couch Systems

Combining functionality with storage and comfort, Specialist Couches assist in making examination and treatment procedures easier and more efficient.



Code: **Sun-CS3/3S**
Specialist treatment couch system with 1 drawerline unit, 1 drawer pack, 3 section upholstery with optional head pillow



White (high gloss) cabinet finish

Titanium (high gloss) cabinet finish





Beech effect cabinet finish



Maple effect cabinet finish

product information

 4 Cabinet finishes	 Maximum user weight (26st.) 165kg	 Multi-position self locking backrest	 Luxury 65mm deep contoured upholstery	 Anti-bacterial/anti-microbial vinyl
 Paper roll holder (supplied as standard)	 Durable silver epoxy coated frame	 Cupboards include pull-out work surface & basket, shelf and lock	 60cm diameter legs for stability with adjustable feet for uneven floors	 Choice of integrated storage solutions
 Optional couch steps (see pages 42-43)	 Easy clean design and materials	 Anti-bacterial Vinyl Strength Test BS EN ISO 13934-1: 2013 BS EN ISO 13973-3: 2000 BS EN ISO 12947-2: 1998	 Fire (Flammability) Testing Flammability BS 7176 Medium Hazard BS 5852 : 2006 Clause 11 (composites)	 FIRA Standard 6250 2005 Specification: Adhesion Performance General/Severe

accessories * these accessories can only be fitted when ordered with the couch

 Sun-CBH1* Breathing Hole	 Sun-CHP1 Head Pillow	 Sun-MCD1 Single Drawer Unit	 Sun-CDT2 Drawer Insert (each)	 Sun-CPS2 Pull-out Work Surface
 Sun-CMU1 Mobile Storage Unit (with locking door)	 Sun-PB1* Pull-out Basket for Storage Unit	 Sun-LEG1* Leg Supports (pair)	 Sun-INST1* Installation Service & Packaging Recycling	 Sun-DISPOSAL1*/** Removal & Disposal of Old Couch

** Removal from ground floor only - weight and removal restrictions apply, please enquire

dimensions



HEAVY ITEM

79cm(H) 193cm(L) 60cm(W) with paper roll holder

Mobile Storage Unit
58cm(H) 50cm(W) 60cm(D)

anti-bacterial vinyl upholstery colours - please specify when ordering

please see inside back cover for full specification of our vinyl range

														
black	grey	beige	primrose	walnut	red wine	salmon	lilac	navy	mid blue	sky blue	cool blue	green	mint	white

Stylish, practical and comfortable, Practitioner Couches make examination and treatment procedures easier, combined with contemporary aesthetics.



Code: **Sun-MEC1**
Practitioner deluxe examination couch with optional pull-out work surface, drawer units, mobile storage unit, leg supports, step and head pillow



White (high gloss) cabinet finish



Titanium (high gloss) cabinet finish



Beech effect cabinet finish



Maple effect cabinet finish

product information

 Maximum user weight (26st.)	 Multi-position self locking backrest	 Single layer density foam for support & comfort	 Luxury 65mm deep contoured upholstery	 Anti-bacterial/anti-microbial vinyl
 Paper roll holder (supplied as standard)	 Durable silver epoxy coated frame	 Stylish 60cm diameter legs for stability	 4 non marking leg protectors	 Special order upholstery colours available
 Easy clean design and materials	 Anti-bacterial Vinyl Strength Test BS EN ISO 13934-1: 2013 BS EN ISO 13973-3: 2000 BS EN ISO 12947-2: 1998	 Fire (Flammability) Testing Flammability BS 7176 Medium Hazard BS 5852 : 2006 Clause 11 (composites)		

accessories * these accessories can only be fitted when ordered with the couch

 Sun-CBH1* Breathing Hole	 Sun-CHP1 Head Pillow	 Sun-LEG1* Leg Supports (pair)	 Sun-INST1* Installation Service & Packaging Recycling	 Sun-DISPOSAL1** Removal & Disposal of Old Couch
 Sun-MPT51 Vista 15 Under Couch Trolley	 Sun-MPT52 Vista 15 Under Couch Trolley	 Sun-MPT53 Vista 15 Under Couch Trolley	 Vista 15 Under Couch Trolleys (see pages 56-57)	 Couch Steps (see pages 42-43)

** Removal from ground floor only - weight and removal restrictions apply, please enquire

dimensions

HEAVY ITEM
79cm(H) 193cm(L) 60cm(W)
with paper roll holder

anti-bacterial vinyl upholstery colours - please specify when ordering

please see inside back cover for full specification of our vinyl range

black	grey	beige	primrose	walnut	red wine	salmon	lilac	navy	mid blue	sky blue	cool blue	green	mint	white

Simple, strong and durable, Colenso Couches are designed for everyday general healthcare, providing comfort with contemporary design.



Code: **Sun-MPT51**
Vista 15 under couch trolley
4 single depth trays



Code: **Sun-MPT52**
Vista 15 under couch trolley
2 single/1 double depth trays



Code: **Sun-MPT53**
Vista 15 under couch trolley
2 double depth trays

product information

 Low height only 50cm high	 Maximum user weight (26st.) 165kg	 Multi-position self locking backrest	 Single layer density foam for support & comfort	 Luxury 65mm deep contoured upholstery
 Anti-bacterial/anti-microbial vinyl	 Paper roll holder (supplied as standard)	 Durable silver epoxy coated frame	 60cm diameter legs for stability	 4 adjustable feet for uneven floors
 Special order upholstery colours available	 Easy clean design and materials	 Anti-bacterial Vinyl Strength Test BS EN ISO 13934-1: 2013 BS EN ISO 13973-3: 2000 BS EN ISO 12947-2: 1998	 Fire (Flammability) Testing Flammability BS 7176 Medium Hazard BS 5852 : 2006 Clause 11 (composites)	 Anti-bacterial Vinyl

accessories

* these accessories can only be fitted when ordered with the couch

 Sun-CBH1* Breathing Hole	 Sun-CHP1 Head Pillow	 Sun-INST1* Installation Service & Packaging Recycling	 Sun-DISPOSAL1** Removal & Disposal of Old Couch	 Couch Steps (see pages 42-43)
---	---	--	--	--

** Removal from ground floor only - weight and removal restrictions apply, please enquire

dimensions



HEAVY ITEM
50cm(H) 193cm(L) 60cm(W)
with paper roll holder

anti-bacterial vinyl upholstery colours - please specify when ordering

please see inside back cover for full specification of our vinyl range

														
black	grey	beige	primrose	walnut	red wine	salmon	lilac	navy	mid blue	sky blue	cool blue	green	mint	white

Alberti Rest Couches

Designed for resting, recovery or where a reduced height application is required, Alberti Couches are strong, durable, easy to clean while being exceptionally comfortable.



Code: **Sun-RC1**
Alberti rest couch with optional head pillow



product information

 Maximum user weight (24st.)	 Lightweight design only 19kg (excludes carry case)	 Multi-position self locking backrest	 Breathing hole and plug	 Adjustable height range 64cm - 80cm
 Head cradle	 Carrying case	 Quick and easy to erect	 2 year warranty	 Delivery normally within 3-5 working days*

* Please contact us regarding availability for quantities of 10 or more.

dimensions



vinyl upholstery colours - please specify when ordering

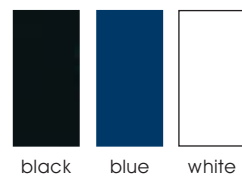

product information

 Maximum user weight (26st.)	 Anti-slip surfaces	 Anti-tipping designs	 Rubber feet prevent movement	 Unique oval design (STP1 & STP2 only)
 Easy clean design and materials	 2 year warranty	 British made	 Delivery normally within 3-5 working days*	

* Please contact us regarding availability for quantities of 10 or more.

dimensions

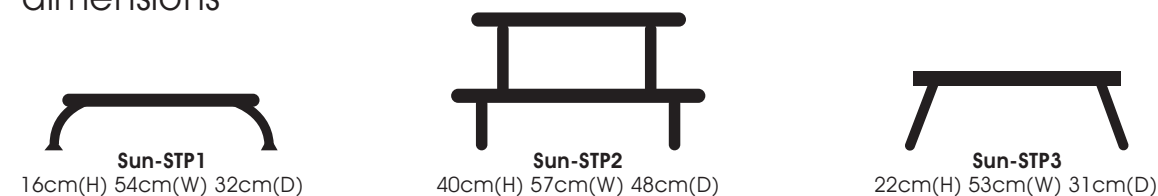

Portable Couches

Lightweight but strong, durable and easy to clean, Portable Couches are ideal for occasional or temporary use as well as for mobile treatment and procedures.



Code: **Sun-PC1**
Portable couch with breathing hole and plug, head cradle and carrying case



Couch Steps

Designed for using with fixed height couches, couch steps are the perfect solution for assisting patients to raise or lower themselves from or to the floor.



Code: **Sun-STP1**
Single tier couch step (oval)





Code: **Sun-STP2**
Double tier couch step (oval)

Code: **Sun-STP3**
Single tier couch step (rectangular)

stable
adjustable
support

Phlebotomy Chairs, Operator Chairs & Examination Stools

Hygienically designed and with patient comfort in mind, phlebotomy chairs are a simple solution for taking blood, whilst operator chairs and examination stools provide support for clinicians.

	PAGE
 Reclining Phlebotomy Chair	45-46
 Phlebotomy/Treatment Chairs	47-48
 Operator Chairs	49-50
 Examination Stools	51-52
 Examination Stools with Back Rests	53-54

product information

 50cm Fixed height seat	 Maximum user weight (35st.)	 50mm Locking castors for stability & easy movement (PHLEB2)	 4 Adjustable feet (PHLEB1)	 Optional padded arm supports
 Luxury 60mm thick padded upholstery for comfort	 Self locking gas assisted back section adjustment	 Hoist clearance 13cm	 Head and foot, up or down -10°/+10° for patient emergencies	 One fully adjustable phlebotomy arm as standard (can be used either side)
 Double layer density foam for support & comfort	 Anti-bacterial/anti-microbial vinyl	 Paper roll holder (supplied as standard)	 Easy clean design and materials	 Anti-bacterial Vinyl Strength Test BS EN ISO 13934-1: 2013 BS EN ISO 13973-3: 2000 BS EN ISO 12947-2: 1998



Anti-bacterial Vinyl
Fire (Flammability) Testing
Flammability BS 7176 Medium Hazard
BS 5852 : 2006 Clause 11 (composites)

accessories

* these accessories can only be fitted when ordered with the couch

 Sun-PHLEB/PHB1 Additional Phlebotomy Arm (each)	 Sun-CHP1 Head Pillow	 Sun-PHLEB/IV2* IV Pole Attachment	 Sun-PHLEB/PAS1 Padded Arm Supports (each)	 Sun-INST1* Installation Service & Packaging Recycling
---	--	---	---	---



Sun-DISPOSAL1*/**
Removal & Disposal of Old Couch

** Removal from ground floor only - weight & removal restrictions apply, please enquire

dimensions

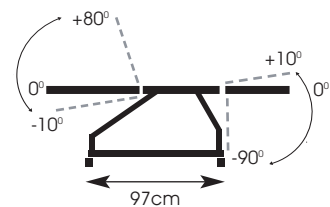

170cm(L) 65cm(W) 50cm(H)



anti-bacterial vinyl upholstery colours - please specify when ordering

please see inside back cover for full specification of our vinyl range



The new Fixed Height Reclining Treatment Chair range has been designed using our extensive knowledge to provide a trusted, ergonomic design providing comfort for the patient and comfortable patient positioning for the clinician. The chair features a robust locking bar and gas strut backrest arrangement allowing the patient to rapidly go from a seated position to head down, feet up position in only 2 movements. The leg section with locking bars is easy to adjust and gives a wide range of positions.



In emergency situations for patient recovery chair goes head down -10° and foot up +10°



Code: Sun-PHLEB1
Fixed Height Phlebotomy Chair - with adjustable feet



Code: Sun-PHLEB2
Fixed Height Phlebotomy Chair - with 4 locking castors



2 year warranty on all moving components



Normally delivered within 7-10 working days (*UK Only)



Code: Sun-PHLEB2
Fixed Height Phlebotomy Chair - with 4 locking castors

product information

Maximum user weight (17st.)	Lightweight design only 8kgs	Multi-position arm rest, made from a hygienic PU moulding	Arm rest can be positioned either side (2 brackets supplied)	Ergonomically designed moulded seat & back (Sun-PCHA only)
Anti-bacterial/anti-microbial vinyl (Sun-PCHA/VYL only)	40mm Deep foam for support and comfort (Sun-PCHA/VYL only)	Easy clean design and materials	1 year warranty	Supplied fully assembled
Independently tested	Anti-bacterial Vinyl Strength Test BS EN ISO 13934-1: 2013 BS EN ISO 13973-3: 2000 BS EN ISO 12947-2: 1998	Fire (Flammability) Testing Flammability BS 7176 Medium Hazard BS 5852 : 2006 Clause 11 (composites)	British made	CE marked

accessories



Sun-PCHA/Arm
Additional Arm Rest

dimensions



83cm(H) 70cm(W) 56cm(D)
Including arm brackets (excluding arm)
Seat Height 43.5cm(H)

Arm Rest
35cm(D)
49cm(H)
Maximum user weight 110kg (17st.)
12cm(D)
35cm(H)

moulded seat & back colours - please specify when ordering



anti-bacterial vinyl upholstery colours - please specify when ordering

please see inside back cover for full specification of our vinyl range



Durable, stable and ergonomically designed, phlebotomy chairs are easy to use and adjust and can be used left, right or dual sided with an additional arm, whilst also being easy to clean.



Code: **Sun-PCHA**
Phlebotomy chair
Moulded seat and back, one arm rest



CODE: **Sun-PCHA/VYL**
Phlebotomy chair
Vinyl upholstery, one arm rest

product information

 Maximum user weight (17st.)	 Anti-bacterial/ anti-microbial vinyl	 Comfortable padded seat and back	 40mm Deep foam for support and comfort	 Hygienic rounded corners
 Strong and durable ergonomic arms (CHA2 & CHA4)	 Adjustable height chrome foot ring provides leg support (CHA3, CHA4 & CHA5)	 Gas-assisted height adjustment	 Five castor base for stability and manoeuvrability	 Glides reduce lateral movement (CHA5 only)
HEIGHT RANGE 42-57cm Sun-CHA1	HEIGHT RANGE 42-57cm Sun-CHA2	HEIGHT RANGE 48-68cm Sun-CHA3	HEIGHT RANGE 48-68cm Sun-CHA4	HEIGHT RANGE 55-81cm Sun-CHA5
 Easy clean design and materials	 Anti-bacterial Vinyl Strength Test BS EN ISO 13934-1: 2013 BS EN ISO 13973-3: 2000 BS EN ISO 12947-2: 1998	 Fire (Flammability) Testing Flammability BS 7176 Medium Hazard BS 5852 : 2006 Clause 11 (composites)	 2 year warranty	 British made

Delivery normally within 3-5 working days * * Please contact us regarding availability for quantities of 10 or more.

dimensions

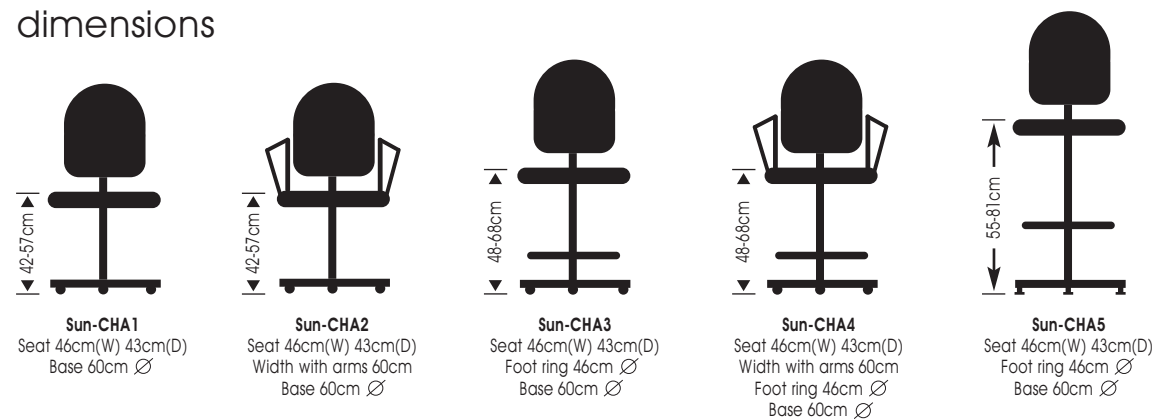

anti-bacterial vinyl upholstery colours - please specify when ordering

please see inside back cover for full specification of our vinyl range



Adjustable for support and comfort, Operator Chairs are designed for everyday general healthcare use, therefore are comfortable, strong, durable and easy to clean.



Code: Sun-CHA1 - Gas-lift chair



Code: Sun-CHA2 - Gas-lift chair with arms



Code: Sun-CHA3 - Gas-lift chair & foot ring



Code: Sun-CHA4 - Gas-lift chair with arms & foot ring







Code: Sun-CHA5 - High level gas-lift chair & foot ring

product information

 Maximum user weight (17st.)	 Anti-bacterial/anti-microbial vinyl	 Luxury 65mm deep upholstery	 2 layer foam for support and comfort	 Adjustable height chrome foot ring (STO3 & STO3/GLIDES)
 Gas-assisted height adjustment	 Sun-STO2 HEIGHT RANGE 42-58cm	 Sun-STO2/GLIDES HEIGHT RANGE 39-55cm	 Sun-STO3 HEIGHT RANGE 51-69cm	 Sun-STO3/GLIDES HEIGHT RANGE 48-66cm
 Five castor base for stability and manoeuvrability	 Glides reduce lateral movement (STO2/GLIDES & STO3/GLIDES only)	 Easy clean design and materials	 Anti-bacterial Vinyl Strength Test BS EN ISO 13934-1: 2013 BS EN ISO 13973-3: 2000 BS EN ISO 12947-2: 1998	 Anti-bacterial Vinyl Fire (Flammability) Testing BS 5852 : 2006 Clause 11 (composites)
 2 year warranty	 British made	 Delivery normally within 3-5 working days *		

* Please contact us regarding availability for quantities of 10 or more.

dimensions

 Sun-STO2 Seat 37cm Ø Base 60cm Ø	 Sun-STO2/GLIDES Seat 37cm Ø Base 60cm Ø	 Sun-STO3 Seat 37cm Ø Foot ring 46cm Ø Base 60cm Ø	 Sun-STO3/GLIDES Seat 37cm Ø Foot ring 46cm Ø Base 60cm Ø
---	--	---	--

anti-bacterial vinyl upholstery colours - please specify when ordering

please see inside back cover for full specification of our vinyl range

														
black	grey	beige	primrose	walnut	red wine	salmon	lilac	navy	mid blue	sky blue	cool blue	green	mint	white

Designed for everyday general healthcare use, Examination Stools can be static or mobile, are simple to adjust and comfortable, while being strong, durable and easy to clean.



Code: Sun-STO2
Gas-lift stool with 5 castor base



Code: Sun-STO2/GLIDES
Gas-lift stool with 5 glides













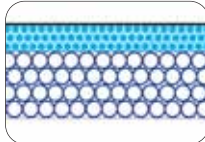



Code: Sun-STO3
Gas-lift stool & foot ring with 5 castor base



Code: Sun-STO3/GLIDES
Gas-lift stool & foot ring with 5 glides

product information

 Maximum user weight (17st.)	 Anti-bacterial/anti-microbial vinyl	 Comfortable padded back rest	 Luxury 65mm deep seat with upholstered back rest	 2 layer foam for support and comfort
 Adjustable height chrome foot ring (Sun-STO5 & Sun-STO6)	 Gas-assisted height adjustment	 HEIGHT RANGE 42-58cm Sun-STO4	 HEIGHT RANGE 53-79cm Sun-STO5	 HEIGHT RANGE 42-58cm Sun-STO6
 Five castor base for stability & manoeuvrability (Sun-STO4 & Sun-STO6)	 Glides reduce lateral movement (Sun-STO5)	 Easy clean design and materials	 Independently tested by FIRA Anti-bacterial Vinyl Strength Test BS EN ISO 13934-1: 2013 BS EN ISO 13973-3: 2000 BS EN ISO 12947-2: 1998	 Anti-bacterial Vinyl Fire (Flammability) Testing Flammability BS 7176 Medium Hazard BS 5852 : 2006 Clause 11 (composites)
 2 year warranty	 British made	 Delivery normally within 3-5 working days *	* Please contact us regarding availability for quantities of 10 or more.	

dimensions

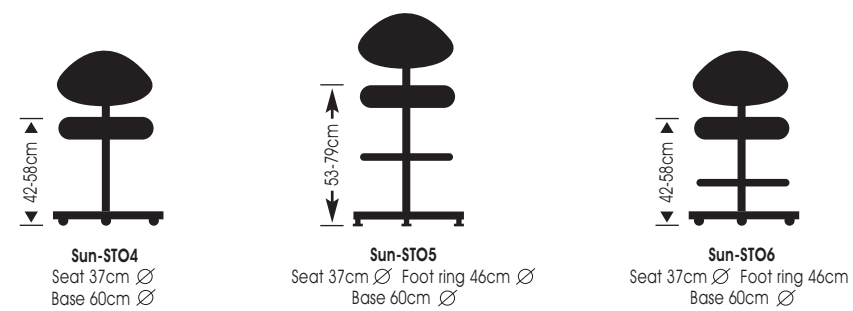

anti-bacterial vinyl upholstery colours - please specify when ordering

please see inside back cover for full specification of our vinyl range



Designed for everyday general healthcare use, Examination Stools with back rests can be static or mobile, are simple to adjust and comfortable, while being strong, durable and easy to clean.



Code: Sun-STO4
Gas -lift stool with back rest



Code: Sun-STO6
Gas -lift stool with back rest and foot ring









Code: Sun-STO5
High level gas -lift stool with back rest, foot ring and glides

visual accessible storage

Vista® Trolleys & Storage

Flexible, modular and colourful, Vista incorporates a mobile or fixed storage solution for every healthcare environment, using premium materials which are all easy to clean. A lockable option is available on most of the range.

	PAGE
 Vista Trolleys	56-71
 Vista Clinical Trolleys	72-79
 Vista Colour Concept Clinical Trolleys	80-81
 Vista Action Station Trolleys	82-85
 Vista Storage Modules	86-89
 Vista Base & Larder Cabinets	90-91

product information



Tilt & locking tray runner system



Trays integrate with all other Vista products



100mm castors with front brakes (Vista 15 only)



Optional tamper resistant locking door (Vista 15 only)



Extra low level (68cm), ideal for under couches (Vista 15 only)



Stainless steel handle (Vista 15 only)



Removable top shelf with integrated upstand (Vista 15 only)



Easy clean design and materials



2 year warranty



British Made

accessories

* These accessories can only be fitted when ordered with the trolley



Sun-LC3A *
4 Antistatic Castors (front 2 braked)



Sun-BUF2 *
4 Protective Buffers (Vista 10 Trolleys)



Sun-BUF3 *
4 Protective Buffers (Vista 15 Trolleys)



Sun-MPT51 *
Folding Shelf



Sun-SBOX1 */**
Sharps Box Bracket (Daniels - All Sizes)



Sun-SBOX2 */**
Sharps Box Bracket (Frontier) Upto 1 Litre



Sun-SBOX3 */**
Sharps Box Bracket (Frontier) 2 & 3 Litre



Sun-MPT/AGH1 */**
Alcohol Gel Holder



Sun-GBH1 */**
Glove Box Holder



Sun-MPT/Rail1 *
Medi-rail



Sun-MPT/BIN *
2.5 Litre Bin (Requires Medi-rail)



Sun-MPT51/LD */***
Tamper Resistant Locking Door (Vista 15 Trolleys)



Sun-DIV1
Single Depth Tray Dividers (per set) Vista 10 & 15



Sun-DIV4
Double Depth Tray Dividers (per set) Vista 15



Sun-MPT1/CV
Trolley Cover (Vista 10 Trolleys)



Sun-MPT51/CV
Trolley Cover (Vista 15 Trolleys)

** Includes Medi-rail

*** Locking door option includes a secure top and back panel

dimensions

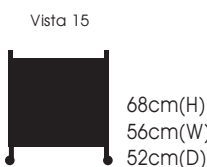
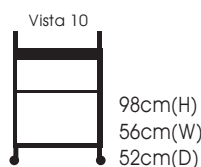

Single Depth Trays
8cm(H) 47cm(W) 42cm(D)
Double Depth Trays
16cm(H) 47cm(W) 42cm(D)

tray colours

please specify when ordering (Tray labels and covers included)



clear blue green

Vista® 10 & 15 Trolleys

Vista 10 is an economy priced trolley without any compromise on quality, while Vista 15 is designed to fit under a couch, both trolleys are functional, durable and easy to clean.



Code: **Sun-TRO1**
Vista 10 Trolley - 1 tray & 1 shelf



Code: **Sun-MPT51**
Vista 15 Trolley - 4 single depth trays



Code: **Sun-MPT51/LD**
Locking door for Vista 15 trolley



Code: **Sun-MPT52**
Vista 15 Trolley - 2 single/1 double depth trays



Code: **Sun-MPT53**
Vista 15 Trolley - 2 double depth trays

product information

 Tilt & locking tray runner system	 Trays integrate with all other Vista products	 Narrow width (39cm) compact design	 100mm castors with front brakes	 Optional tamper resistant locking door
 Removable top shelf with integrated upstand	 Easy clean design and materials	 2 year warranty	 Supplied fully assembled	 British made

accessories * These accessories can only be fitted when ordered with the trolley

 Sun-LC3A * 4 Antistatic Castors (front 2 braked)	 Sun-BUF2 * 4 Protective Buffers	 Sun-MPTS1 * Folding Shelf	 Sun-SBOX1 */** Sharps Box Bracket (Daniels - All Sizes)	 Sun-SBOX2 */** Sharps Box Bracket (Frontier) Upto 1 Litre
 Sun-SBOX3 */** Sharps Box Bracket (Frontier) 2 & 3 Litre	 Sun-MPT/AGH1 */** Alcohol Gel Holder	 Sun-GBH1 */** Glove Box Holder	 Sun-MPT/Rail1 * Medi-rail	 Sun-MPT/BIN * 2.5 Litre Bin (Requires Medi-rail)
 Sun-MPT5/LD */*** Tamper Resistant Locking Door	 Sun-DIV2 Double Depth Tray Dividers (per set)	 Sun-DIV3 Single Depth Tray Dividers (per set)	 Sun-MPT5/CV Trolley Cover	

** Includes Medi-rail *** Locking door option includes a secure top and back panel

dimensions

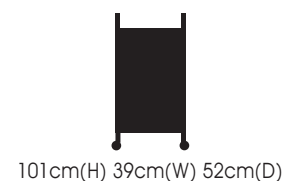

Single Depth Trays
8cm(H) 31cm(W) 42cm(D)
Double Depth Trays
16cm(H) 31cm(W) 42cm(D)

tray colours

please specify when ordering
(Tray labels and covers included)



clear blue green

Vista® 30 Trolleys

Designed for environments with limited space, Vista 30 provides standard working height with compact design, optimum storage, and is functional, durable and easy to clean.



Code: **Sun-MPT10**
Vista 30 Trolley - 6 single depth trays



Code: **Sun-MPT5/LD**
Locking door for Vista 30 trolley



Code: **Sun-MPT5**
Vista 30 Trolley - 2 single/2 double depth trays



Code: **Sun-MPT5/LD**
Locking door for Vista 30 trolley



Code: **Sun-MPT6**
Vista 30 Trolley - 3 double depth trays



Code: **Sun-MPT5/LD**
Locking door for Vista 30 trolley

product information



accessories

* These accessories can only be fitted when ordered with the trolley



** Includes Medi-rail

*** Locking door option includes a secure top and back panel

dimensions

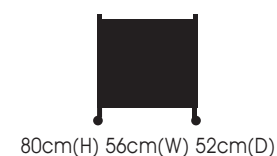

Single Depth Trays
8cm(H) 47cm(W) 42cm(D)
Double Depth Trays
16cm(H) 47cm(W) 42cm(D)

tray colours

please specify when ordering
(Tray labels and covers included)



Vista® 40 Trolleys

Designed to fit under a worktop, Vista 40 can be stored neatly away, while providing optimum number of trays for storage, and is functional, durable and easy to clean.



Code: **Sun-MPT40** Vista 40 Trolley
5 single depth trays



Code: **Sun-MPT40/LD**
Locking door for Vista 40 trolley



Code: **Sun-MPT41** Vista 40 Trolley
3 single/1 double depth trays



Code: **Sun-MPT40/LD**
Locking door for Vista 40 trolley



Code: **Sun-MPT42** Vista 40 Trolley
1 single/2 double depth trays



Code: **Sun-MPT40/LD**
Locking door for Vista 40 trolley

product information



Tilt & locking tray runner system



Trays integrate with all other Vista products



100mm castors with front brakes



Optional tamper resistant locking door



Removable top shelf with integrated upstand



Easy clean design and materials



2 year warranty



Supplied fully assembled



British made

accessories

* These accessories can only be fitted when ordered with the trolley



Sun-LC3A *
4 Antistatic Castors (front 2 braked)



Sun-BUF2 *
4 Protective Buffers



Sun-MPT/OXY1 **
Oxygen Bottle Holder (Size D)



Sun-MPT/LAP1 **
Adjustable Height Laptop Holder



Sun-MPT/CHART1 **
Adjustable Height Chart Holder



Sun-MPT/DRIP1 **
Adjustable Height Drip Pole



Sun-MPTS1 *
Folding Shelf



Sun-SBOX1 **
Sharps Box Bracket (Daniels - All Sizes)



Sun-SBOX2 **
Sharps Box Bracket (Frontier) Upto 1 Litre



Sun-SBOX3 **
Sharps Box Bracket (Frontier) 2 & 3 Litre



Sun-MPT/AGH1 **
Alcohol Gel Holder



Sun-GBH1 **
Glove Box Holder



Sun-MPT/Rail1 *
Medi-rail



Sun-MPT/BIN *
2.5 Litre Bin (Requires Medi-rail)



Sun-MPT/LD **
Tamper Resistant Locking Door



Sun-DIV1
Single Depth Tray Dividers (per set)



Sun-DIV4
Double Depth Tray Dividers (per set)



Sun-MPT1/CV
Trolley Cover

** Includes Medi-rail

*** Locking door option includes a secure top and back panel

dimensions

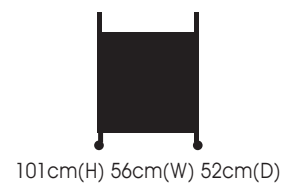

Single Depth Trays
8cm(H) 47cm(W) 42cm(D)
Double Depth Trays
16cm(H) 47cm(W) 42cm(D)

tray colours

please specify when ordering
(Tray labels and covers included)

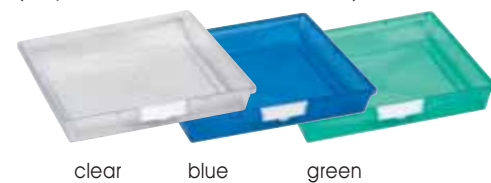

clear blue green

Vista® 50 Trolleys

Suitable for everyday general healthcare use, Vista 50 provides standard working height with generous working space, optimum tray storage, and is functional, durable and easy to clean.



Code: **Sun-MPT1**
Vista 50 Trolley - 6 single depth trays



Code: **Sun-MPT1/LD**
Locking door for Vista 50 trolley



Code: **Sun-MPT2**
Vista 50 Trolley - 4 single/1 double depth trays



Code: **Sun-MPT1/LD**
Locking door for Vista 50 trolley



Code: **Sun-MPT13**
Vista 50 Trolley - 3 double depth trays



Code: **Sun-MPT1/LD**
Locking door for Vista 50 trolley

product information

				
Tilt & locking tray runner system	Trays integrate with all other Vista products	100mm castors with front brakes	Optional tamper resistant locking door	Removable top shelf with integrated upstand
				
Easy clean design and materials	2 year warranty	Supplied fully assembled	British made	

accessories * These accessories can only be fitted when ordered with the trolley

				
Sun-LC3A * 4 Antistatic Castors (front 2 braked)	Sun-BUF2 * 4 Protective Buffers	Sun-MPT/OXY1 ** Oxygen Bottle Holder (Size D)	Sun-MPT/LAP1 ** Adjustable Height Laptop Holder	Sun-MPT/CHART1 ** Adjustable Height Chart Holder
				
Sun-MPT/DRIP1 ** Adjustable Height Drip Pole	Sun-MPTS1 * Folding Shelf	Sun-SBOX1 ** Sharps Box Bracket (Daniels - All Sizes)	Sun-SBOX2 ** Sharps Box Bracket (Frontier) Upto 1 Litre	Sun-SBOX3 ** Sharps Box Bracket (Frontier) 2 & 3 Litre
				
Sun-MPT/AGH1 ** Alcohol Gel Holder	Sun-GBH1 ** Glove Box Holder	Sun-MPT/Rail1 * Medi-rail	Sun-MPT/BIN * 2.5 Litre Bin (Requires Medi-rail)	Sun-MPT55/LD ** Tamper Resistant Locking Door
				
Sun-DIV1 Single Depth Tray Dividers (per set)	Sun-DIV4 Double Depth Tray Dividers (per set)	Sun-MPT55/CV Trolley Cover		

** Includes Medi-rail *** Locking door option includes a secure top and back panel

dimensions

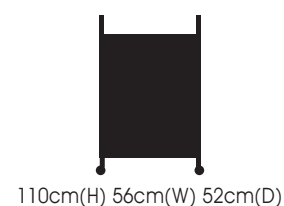

Single Depth Trays
8cm(H) 47cm(W) 42cm(D)
Double Depth Trays
16cm(H) 47cm(W) 42cm(D)

tray colours

please specify when ordering
(Tray labels and covers included)

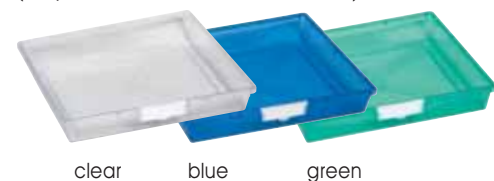

clear blue green

Vista® 55 Trolleys

Suitable for everyday general healthcare use, Vista 55 provides standard working height with generous working space, smart design optimises storage with upto seven trays, and is functional, durable and easy to clean.



Code: Sun-MPT55
Vista 55 Trolley - 7 single depth trays



Code: Sun-MPT55/LD
Locking door for Vista 55 trolley



Code: Sun-MPT56
Vista 55 Trolley - 3 single/2 double depth trays



Code: Sun-MPT55/LD
Locking door for Vista 55 trolley



Code: Sun-MPT57
Vista 55 Trolley - 1 single/3 double depth trays



Code: Sun-MPT55/LD
Locking door for Vista 55 trolley

product information



Tilt & locking tray runner system



Trays integrate with all other Vista products



100mm castors with front brakes



Optional tamper resistant locking doors



Removable top shelf with integrated upstand



Easy clean design and materials



2 year warranty



Supplied fully assembled



British made

accessories

* These accessories can only be fitted when ordered with the trolley



Sun-LC3A *
4 Antistatic Castors (front 2 braked)



Sun-BUF2 *
4 Protective Buffers



Sun-MPT/OXY1 */**
Oxygen Bottle Holder (Size D)



Sun-MPT/LAP1 */**
Adjustable Height Laptop Holder



Sun-MPT/CHART1 */**
Adjustable Height Chart Holder



Sun-MPT/DRIP1 */**
Adjustable Height Drip Pole



Sun-MPTS1 *
Folding Shelf



Sun-SBOX1 */**
Sharps Box Bracket (Daniels - All Sizes)



Sun-SBOX2 */**
Sharps Box Bracket (Frontier) Upto 1 Litre



Sun-SBOX3 */**
Sharps Box Bracket (Frontier) 2 & 3 Litre



Sun-MPT/AGH1 */**
Alcohol Gel Holder



Sun-GBH1 */**
Glove Box Holder



Sun-MPT/Rail1 *
Medi-rail



Sun-MPT/BIN *
2.5 Litre Bin (Requires Medi-rail)



Sun-MPT60/LD */**
2 Tamper Resistant Locking Doors



Sun-DIV2
Double Depth Tray Dividers (per set)



Sun-DIV3
Single Depth Tray Dividers (per set)



Sun-MPT60/CV
Trolley Cover

** Includes Medi-rail

*** Locking door option includes a secure top and back panel

dimensions



101cm(H) 70cm(W) 52cm(D)

Single Depth Trays
8cm(H) 31cm(W) 42cm(D)

Double Depth Trays
16cm(H) 31cm(W) 42cm(D)

tray colours

please specify when ordering
(Tray labels and covers included)



clear blue green

Vista® 60 Trolleys

Designed to optimise storage where space is limited, Vista 60 provides additional working space and compact storage with upto 12 trays, and is functional, durable and easy to clean.



Code: **Sun-MPT60**
Vista 60 Trolley - 12 single depth trays



Code: **Sun-MPT60/LD**
2 Locking doors for Vista 60 trolley



Code: **Sun-MPT61**
Vista 60 Trolley - 6 single/3 double depth trays



Code: **Sun-MPT60/LD**
2 Locking doors for Vista 60 trolley



Code: **Sun-MPT62**
Vista 60 Trolley - 6 double depth trays



Code: **Sun-MPT60/LD**
2 Locking doors for Vista 60 trolley

product information



Tilt & locking tray runner system



Trays integrate with all other Vista products



100mm castors with front brakes



Optional tamper resistant locking doors



Removable top shelf with integrated upstand



Easy clean design and materials



2 year warranty



Supplied fully assembled



British made

accessories

* These accessories can only be fitted when ordered with the trolley



Sun-LC3A *
4 Antistatic Castors (front 2 braked)



Sun-BUF2 *
4 Protective Buffers



Sun-MPT/OXY1 */**
Oxygen Bottle Holder (Size D)



Sun-MPT/LAP1 */**
Adjustable Height Laptop Holder



Sun-MPT/CHART1 */**
Adjustable Height Chart Holder



Sun-MPT/DRIP1 */**
Adjustable Height Drip Pole



Sun-MPTS1 *
Folding Shelf



Sun-SBOX1 */**
Sharps Box Bracket (Daniels - All Sizes)



Sun-SBOX2 */**
Sharps Box Bracket (Frontier) Upto 1 Litre



Sun-SBOX3 */**
Sharps Box Bracket (Frontier) 2 & 3 Litre



Sun-MPT/AGH1 */**
Alcohol Gel Holder



Sun-GBH1 */**
Glove Box Holder



Sun-MPT/Rail1 *
Medi-rail



Sun-MPT/BIN *
2.5 Litre Bin (Requires Medi-rail)



Sun-MPT4/LD */**
2 Tamper Resistant Locking Doors



Sun-DIV1
Single Depth Tray Dividers (per set)



Sun-DIV4
Double Depth Tray Dividers (per set)



Sun-MPT4/CV
Trolley Cover

** Includes Medi-rail

*** Locking door option includes a secure top and back panel

dimensions



101cm(H) 103cm(W) 52cm(D)

Single Depth Trays
8cm(H) 47cm(W) 42cm(D)
Double Depth Trays
16cm(H) 47cm(W) 42cm(D)

tray colours

please specify when ordering
(Tray labels and covers included)

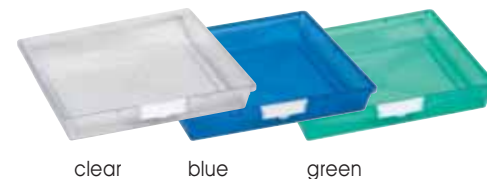

clear blue green

Vista® 100 Trolleys

Designed for the most demanding healthcare environments, Vista 100 combines maximum working space with optimum tray storage, and is functional, durable and easy to clean.



Code: **Sun-MPT16**
Vista 100 Trolley - 12 single depth trays



Code: **Sun-MPT4/LD**
2 Locking doors for Vista 100 trolley



Code: **Sun-MPT4**
Vista 100 Trolley - 8 single/2 double depth trays



Code: **Sun-MPT4/LD**
2 Locking doors for Vista 100 trolley



Code: **Sun-MPT17**
Vista 100 Trolley - 6 single/3 double depth trays



Code: **Sun-MPT4/LD**
2 Locking doors for Vista 100 trolley

product information



Tilt & locking tray runner system



Trays integrate with all other Vista products



100mm castors with front brakes



Removable top shelf



Easy clean design and materials



2 year warranty



Supplied fully assembled



British made

accessories

* These accessories can only be fitted when ordered with the trolley



Sun-LC3A *
4 Antistatic Castors (front 2 braked)



Sun-BUF3 *
4 Protective Buffers



Sun-MPT/OXY1 */**
Oxygen Bottle Holder (Size D)



Sun-MPTS1 *
Folding Shelf



Sun-SBOX1 */**
Sharps Box Bracket (Daniels - All Sizes)



Sun-SBOX2 */**
Sharps Box Bracket (Frontier) Upto 1 Litre



Sun-SBOX3 */**
Sharps Box Bracket (Frontier) 2 & 3 Litre



Sun-MPT/AGH1 */**
Alcohol Gel Holder



Sun-GBH1 */**
Glove Box Holder



Sun-MPT/Rail1 *
Medi-rail



Sun-MPT/BIN *
2.5 Litre Bin (Requires Medi-rail)



Sun-DIV1
Single Depth Tray Dividers (per set)



Sun-DIV4
Double Depth Tray Dividers (per set)

** Includes Medi-rail

dimensions

Vista 120	Vista 240
146cm(H) 54cm(W) 50cm(D)	146cm(H) 102cm(W) 50cm(D)

Single Depth Trays
8cm(H) 47cm(W) 42cm(D)
Double Depth Trays
16cm(H) 47cm(W) 42cm(D)

tray colours

please specify when ordering
(Tray labels and covers included)

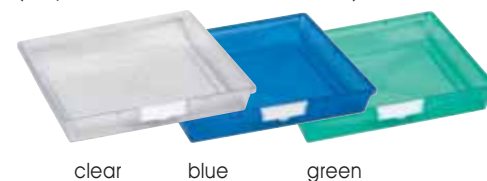

Vista® 120 & 240 Trolleys

Suitable for healthcare environments with demanding mobile storage requirements and limited space, Vista 120 & 240 combine high level storage, with multiple tray configurations and are functional, durable and easy to clean.



Code: **Sun-MPT120**
Vista 120 Trolley - 12 single depth trays



Code: **Sun-MPT240**
Vista 240 Trolley - 24 single depth trays



Code: **Sun-MPT121**
Vista 120 Trolley - 6 single/3 double depth trays



Code: **Sun-MPT241**
Vista 240 Trolley - 12 single/6 double depth trays



Code: **Sun-MPT122**
Vista 120 Trolley - 6 double depth trays



Code: **Sun-MPT242**
Vista 240 Trolley - 12 double depth trays

product information

				
Tilt & locking tray runner system	Trays integrate with all other Vista products	Removable mirror polished recessed stainless steel tray (304 grade)	Narrow width (39cm) compact design	100mm castors with front brakes
				
4 Protective buffers as standard	Optional tamper resistant locking door	Easy clean design and materials	2 year warranty	Supplied fully assembled
				
British made				

accessories * These accessories can only be fitted when ordered with the trolley

				
Sun-LC3A * 4 Antistatic Castors (front 2 braked)	Sun-MPTS1 * Folding Shelf	Sun-SBOX1 */** Sharps Box Bracket (Daniels - All Sizes)	Sun-SBOX2 */** Sharps Box Bracket (Frontier) Upto 1 Litre	Sun-SBOX3 */** Sharps Box Bracket (Frontier) 2 & 3 Litre
				
Sun-MPT/AGH1 */** Alcohol Gel Holder	Sun-GBH1 */** Glove Box Holder	Sun-MPT/Rail1 * Medi-rail	Sun-MPT/BIN * 2.5 Litre Bin (Requires Medi-rail)	Sun-CVT30/LD */*** Tamper Resistant Locking Door
				
Sun-DIV2 Double Depth Tray Dividers (per set)	Sun-DIV3 Single Depth Tray Dividers (per set)	Sun-MPT5/CV Trolley Cover		

** Includes Medi-rail *** Locking door option includes a secure top and back panel

dimensions



101cm(H) 39cm(W) 52cm(D)
47cm(W) 60cm(D) with buffers

Single Depth Trays
8cm(H) 31cm(W) 42cm(D)
Double Depth Trays
16cm(H) 31cm(W) 42cm(D)

tray colours

please specify when ordering
(Tray labels and covers included)

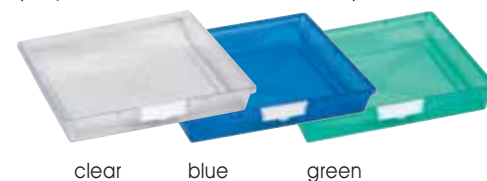

Designed for environments with limited space, Vista 30 Clinical provides standard working height with compact design, optimum storage, a removable recessed stainless steel tray and is functional, durable and easy to clean.



Code: **Sun-CVT30**
Vista 30 Clinical trolley - 6 single depth trays



Code: **Sun-CVT30/LD**
Locking door for Vista 30 clinical trolley



Code: **Sun-CVT31**
Vista 30 Clinical trolley - 2 single/2 double depth trays



Code: **Sun-CVT30/LD**
Locking door for Vista 30 clinical trolley



Code: **Sun-CVT32**
Vista 30 Clinical trolley - 3 double depth trays



Code: **Sun-CVT30/LD**
Locking door for Vista 30 clinical trolley

product information

 Tilt & locking tray runner system	 Trays integrate with all other Vista products	 Removable mirror polished recessed stainless steel tray (304 grade)	 Low level (80cm), ideal for under worktops	 100mm castors with front brakes
 Optional tamper resistant locking door	 Stainless steel handle	 4 Protective buffers as standard	 Easy clean design and materials	 2 year warranty
 Supplied fully assembled	 British made			

accessories * These accessories can only be fitted when ordered with the trolley

 Sun-LC3A * 4 Antistatic Castors (front 2 braked)	 Sun-MPT1 * Folding Shelf	 Sun-SBOX1 */** Sharps Box Bracket (Daniels - All Sizes)	 Sun-SBOX2 */** Sharps Box Bracket (Frontier) Upto 1 Litre	 Sun-SBOX3 */** Sharps Box Bracket (Frontier) 2 & 3 Litre
 Sun-MPT/AGH1 */** Alcohol Gel Holder	 Sun-GBH1 */** Glove Box Holder	 Sun-MPT/Rail1 * Medi-rail	 Sun-MPT/BIN * 2.5 Litre Bin (Requires Medi-rail)	 Sun-CVT40/LD */*** Tamper Resistant Locking Door
 Sun-DIV1 Single Depth Tray Dividers (per set)	 Sun-DIV4 Double Depth Tray Dividers (per set)	 Sun-MPT40/CV Trolley Cover		

** Includes Medi-rail *** Locking door option includes a secure top and back panel

dimensions



80cm(H) 56cm(W) 52cm(D)
64cm(W) 60cm(D) with buffers

Single Depth Trays
8cm(H) 47cm(W) 42cm(D)
Double Depth Trays
16cm(H) 47cm(W) 42cm(D)

tray colours

please specify when ordering
(Tray labels and covers included)

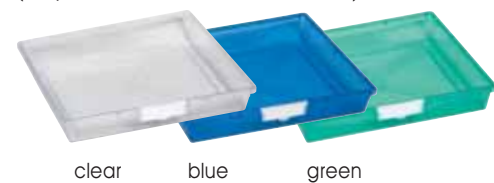

Vista® 40 Clinical Trolleys

Designed to fit under a worktop, Vista 40 Clinical can be stored neatly away, while providing optimum number of trays for storage, removable recessed stainless steel tray and is functional, durable and easy to clean.



Code: **Sun-CVT40**
Vista 40 Clinical trolley
5 single depth trays



Code: **Sun-CVT40/LD**
Locking door for Vista 40 clinical trolley



Code: **Sun-CVT41**
Vista 40 Clinical trolley
3 single/1 double depth tray



Code: **Sun-CVT40/LD**
Locking door for Vista 40 clinical trolley



Code: **Sun-CVT42**
Vista 40 Clinical trolley
1 single/2 double depth trays



Code: **Sun-CVT40/LD**
Locking door for Vista 40 clinical trolley

product information

				
Tilt & locking tray runner system	Trays integrate with all other Vista products	Removable mirror polished recessed stainless steel tray (304 grade)	100mm castors with front brakes	Optional tamper resistant locking door
				
4 Protective buffers as standard	Easy clean design and materials	2 year warranty	Supplied fully assembled	British made

accessories * These accessories can only be fitted when ordered with the trolley

				
Sun-LC3A * 4 Antistatic Castors (front 2 braked)	Sun-MPT/OXY1 ** Oxygen Bottle Holder (Size D)	Sun-MPT/LAP1 ** Adjustable Height Laptop Holder	Sun-MPT/CHART1 ** Adjustable Height Chart Holder	Sun-MPT/DRIP1 ** Adjustable Height Drip Pole
				
Sun-MPTS1 * Folding Shelf	Sun-SBOX1 ** Sharps Box Bracket (Daniels - All Sizes)	Sun-SBOX2 ** Sharps Box Bracket (Frontier) Upto 1 Litre	Sun-SBOX3 ** Sharps Box Bracket (Frontier) 2 & 3 Litre	Sun-MPT/AGH1 ** Alcohol Gel Holder
				
Sun-GBH1 ** Glove Box Holder	Sun-MPT/Rail1 * Medi-rail	Sun-MPT/BIN * 2.5 Litre Bin (Requires Medi-rail)	Sun-CVT50/LD *** Tamper Resistant Locking Door	Sun-DIV1 Single Depth Tray Dividers (per set)
				
Sun-DIV4 Double Depth Tray Dividers (per set)	Sun-MPT1/CV Trolley Cover			

** Includes Medi-rail *** Locking door option includes a secure top and back panel

dimensions



101cm(H) 56cm(W) 52cm(D)
64cm(W) 60cm(D) with buffers

Single Depth Trays
8cm(H) 47cm(W) 42cm(D)
Double Depth Trays
16cm(H) 47cm(W) 42cm(D)

tray colours

please specify when ordering
(Tray labels and covers included)

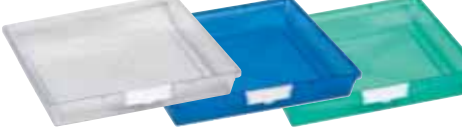

clear blue green

Suitable for everyday general healthcare use, Vista 50 Clinical provides standard working height with generous working space, optimum tray storage, removable recessed stainless steel tray and is functional, durable and easy to clean.



Code: Sun-CVT50
Vista 50 Clinical trolley - 6 single depth trays



Code: Sun-CVT50/LD
Locking door for Vista 50 clinical trolley



Code: Sun-CVT51
Vista 50 Clinical trolley
4 single/1 double depth tray



Code: Sun-CVT50/LD
Locking door for Vista 50 clinical trolley



Code: Sun-CVT52
Vista 50 Clinical Trolley - 3 double depth trays



Code: Sun-CVT50/LD
Locking door for Vista 50 clinical trolley

product information

				
Tilt & locking tray runner system	Trays integrate with all other Vista products	Removable mirror polished recessed stainless steel tray (304 grade)	100mm castors with front brakes	Optional tamper resistant locking doors
				
4 Protective buffers as standard	Easy clean design and materials	2 year warranty	Supplied fully assembled	British made

accessories * These accessories can only be fitted when ordered with the trolley

				
Sun-LC3A * 4 Antistatic Castors (front 2 braked)	Sun-MPT/OXY1 ** Oxygen Bottle Holder (Size D)	Sun-MPT/LAP1 ** Adjustable Height Laptop Holder	Sun-MPT/CHART1 ** Adjustable Height Chart Holder	Sun-MPT/DRIP1 ** Adjustable Height Drip Pole
				
Sun-MPTS1 * Folding Shelf	Sun-SBOX1 ** Sharps Box Bracket (Daniels - All Sizes)	Sun-SBOX2 ** Sharps Box Bracket (Frontier) Upto 1 Litre	Sun-SBOX3 ** Sharps Box Bracket (Frontier) 2 & 3 Litre	Sun-MPT/AGH1 ** Alcohol Gel Holder
				
Sun-GBH1 ** Glove Box Holder	Sun-MPT/Rail1 * Medi-rail	Sun-MPT/BIN * 2.5 Litre Bin (Requires Medi-rail)	Sun-CVT60/LD *** 2 Tamper Resistant Locking Doors	Sun-DIV2 Double Depth Tray Dividers (per set)
				
Sun-DIV3 Single Depth Tray Dividers (per set)	Sun-MPT60/CV Trolley Cover			

** Includes Medi-rail *** Locking door option includes a secure top and back panel

dimensions

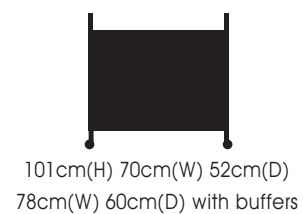

Single Depth Trays
8cm(H) 31cm(W) 42cm(D)
Double Depth Trays
16cm(H) 31cm(W) 42cm(D)

tray colours

please specify when ordering
(Tray labels and covers included)

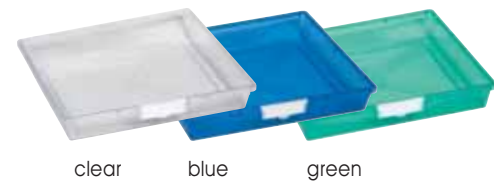

clear blue green

Designed to optimise storage where space is limited, Vista 60 Clinical provides additional working space with compact storage using up to 12 trays, removable recessed stainless steel tray and is functional, durable and easy to clean.



Code: Sun-CVT60
Vista 60 Clinical trolley - 12 single depth trays



Code: Sun-CVT60/LD
2 Locking doors for Vista 60 clinical trolley



Code: Sun-CVT61
Vista 60 Clinical trolley
6 single/3 double depth trays



Code: Sun-CVT60/LD
2 Locking doors for Vista 60 clinical trolley



Code: Sun-CVT62
Vista 60 Clinical trolley - 6 double depth trays



Code: Sun-CVT60/LD
2 Locking doors for Vista 60 clinical trolley

product information

Choice of 5 coloured tray and frame colours	Tilt & locking tray runner system	Trays integrate with all other Vista products	Tamper resistant locking door	Top, bottom and back panels provide added security
Translucent tray lids, tray labels and covers included	Removable top shelf with integrated upstand	Clean & Dirty labels included	100mm castors with front brakes	4 Protective buffers as standard
Front mounted stainless steel handle (Vista 40 only)	Easy clean design and materials	2 year warranty	Supplied fully assembled	British made

accessories

* These accessories can only be fitted when ordered with the trolley

Sun-LC3A * 4 Antistatic Castors (front 2 braked)	Sun-MPT/OXY1 */** Oxygen Bottle Holder Size D (Vista 50 Only)	Sun-MPT/LAP1 */** Adjustable Height Laptop Holder (Vista 50 Only)	Sun-MPT/CHART1 */** Adjustable Height Chart Holder (Vista 50 Only)	Sun-MPT/DRIP1 */** Adjustable Height Drip Pole (Vista 50 Only)
Sun-MPTS1 * Folding Shelf	Sun-SBOX1 */** Sharps Box Holder (Daniels - All Sizes)	Sun-SBOX2 */** Sharps Box Holder (Frontier) Upto 1 Litre	Sun-SBOX3 */** Sharps Box Holder (Frontier) 2 & 3 Litre	Sun-MPT/AGH1 */** Alcohol Gel Holder
Sun-GBH1 */** Glove Box Holder	Sun-MPT/Rail1 * Medi-rail	Sun-MPT/BIN * 2.5 Litre Bin (Requires Medi-rail)	Sun-DIV1 Single Depth Tray Dividers (per set)	Trolley Covers Sun-MPT40/CV (Vista 40 Clinical) Sun-MPT1/CV (Vista 50 Clinical)

** Includes Medi-rail

dimensions

Vista 40 Clinical Trolley	Vista 50 Clinical Trolley
80cm(H) 56cm(W) 52cm(D) 64cm(W) 60cm(D) with buffers	101cm(H) 56cm(W) 52cm(D) 64cm(W) 60cm(D) with buffers

frame & tray colours

please specify when ordering

blue	green	yellow	white/clear	red

Designed for clinical & disinfecting environments, Vista Clinical are colour designated for clean and dirty areas. Vista 50 provides standard working height with maximum tray storage, while Vista 40 fits neatly under a worktop, both trolleys are fully secure, functional, durable and easy to clean.



Code: **Sun-CMPT40**
Vista 40 Clinical Trolley - 5 single depth trays with optional sharps box holder and folding shelf



Code: **Sun-CMPT1**
Vista 50 Clinical Trolley - 6 single depth trays with optional sharps box holder, glove box holder and folding shelf

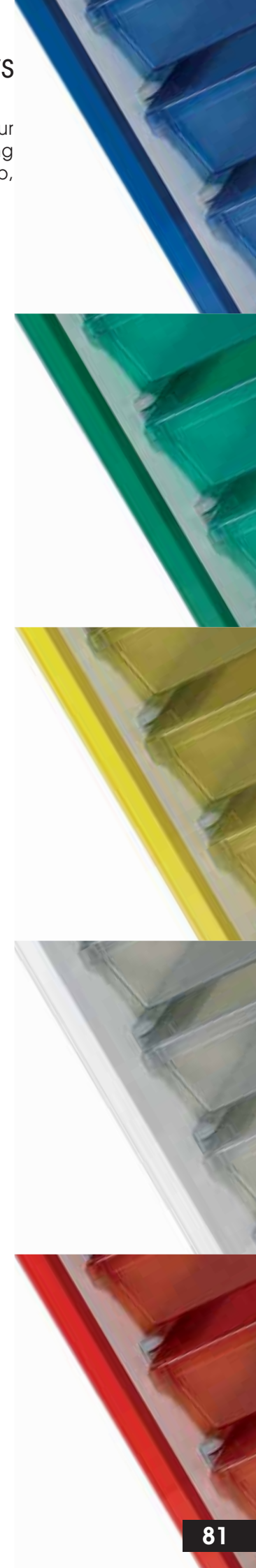

product information

 Designed for "just in time" working	 Laptop or vital pack area	 Medical notes storage in trays	 Tilt & locking tray runner system	 Top locking drawer for secure storage
 Combination lock (no keys required)	 4 Protective buffers as standard	 100mm castors with front brakes	 Removable top shelf with integrated upstand	 Easy clean design and materials
 2 year warranty	 Supplied fully assembled	 British made		

accessories * These accessories can only be fitted when ordered with the trolley

 Sun-LC3A * 4 Antistatic Castors (front 2 braked)	 Sun-MPT/OXY1 */** Oxygen Bottle Holder (Size D)	 Sun-MPTS1 * Folding Shelf	 Sun-SBOX1 */** Sharps Box Bracket (Daniels - All Sizes)	 Sun-SBOX2 */** Sharps Box Bracket (Frontier) Upto 1 Litre
 Sun-SBOX3 */** Sharps Box Bracket (Frontier) 2 & 3 Litre	 Sun-MPT/AGH1 */** Alcohol Gel Holder	 Sun-GBH1 */** Glove Box Holder	 Sun-MPT/Rail1 * Medi-rail	 Sun-MPT/BIN * 2.5 Litre Bin (Requires Medi-rail)
 Sun-MPT/LABEL1 Wipe Clean Labels 2 Per Tray (5 Sets Per Pack)	 Sun-DIV1 Single Depth Tray Dividers (per set)	 Sun-DIV4 Double Depth Tray Dividers (per set)	 Sun-MPT90/LD */*** Tamper Resistant Locking Door	

** Includes Medi-rail *** Locking door option includes a secure top and back panel

dimensions

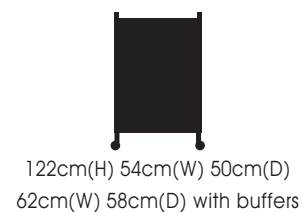

Single Depth Trays
8cm(H) 47cm(W) 42cm(D)
Double Depth Trays
16cm(H) 47cm(W) 42cm(D)

tray colours

please specify when ordering

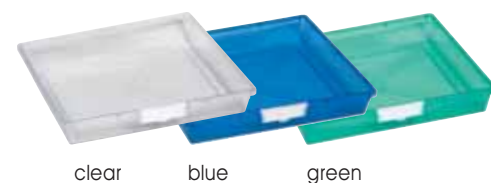

Designed for "just in time" working during ward rounds, Vista 90 Action Station provides working space for a laptop or "Vital Pack" with a lockable top tray, additional tray storage for patient notes and equipment and is functional, durable and easy to clean.



Single column trolley specifically designed in conjunction with leading Consultant Dr Gordon Caldwell FRCP (London), Consultant Physician, of Worthing Hospital, Diabetes Centre for "just in time" working during ward rounds.

Dr Caldwell comments, "I have found that this trolley significantly improves ward round efficiency, it holds the team of doctors around the trolley and gives them a large surface to write on, the horizontal filing system is also far easier to use than traditional vertical files, we more clearly define team members' roles, therefore more productive doctors".



Code: **Sun-MPT90**
Vista 90 Action Station Trolley
9 single depth trays

















Code: **Sun-MPT91**
Vista 90 Action Station Trolley
5 single/ 2 double depth trays

product information

 Designed for "just in time" working	 Laptop or vital pack area	 Medical notes storage in trays	 Tilt & locking tray runner system	 Top locking drawer for secure storage
 Combination lock (no keys required)	 4 Protective buffers as standard	 100mm castors with front brakes	 Removable top shelf with integrated upstand	 Easy clean design and materials
 2 year warranty	 Supplied fully assembled	 British made		

accessories * These accessories can only be fitted when ordered with the trolley

 Sun-LC3A * 4 Antistatic Castors (front 2 braked)	 Sun-MPT/OXY1 */** Oxygen Bottle Holder (Size D)	 Sun-MPTS1 * Folding Shelf	 Sun-SBOX1 */** Sharps Box Bracket (Daniels - All Sizes)	 Sun-SBOX2 */** Sharps Box Bracket (Frontier) Upto 1 Litre
 Sun-SBOX3 */** Sharps Box Bracket (Frontier) 2 & 3 Litre	 Sun-MPT/AGH1 */** Alcohol Gel Holder	 Sun-GBH1 */** Glove Box Holder	 Sun-MPT/Rail1 * Medi-rail	 Sun-MPT/BIN * 2.5 Litre Bin (Requires Medi-rail)
 Sun-MPT/LABEL1 Wipe Clean Labels 2 Per Tray (5 Sets Per Pack)	 Sun-DIV1 Single depth Tray Dividers (per set)	 Sun-DIV4 Double Depth Tray Dividers (per set)	 Sun-MPT180/LD */*** 2 Tamper Resistant Locking Doors	

** Includes Medi-rail *** Locking door option includes a secure top and back panel

dimensions

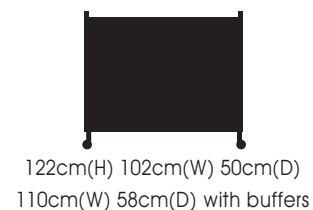

Single Depth Trays
8cm(H) 47cm(W) 42cm(D)
Double Depth Trays
16cm(H) 47cm(W) 42cm(D)

tray colours

please specify when ordering

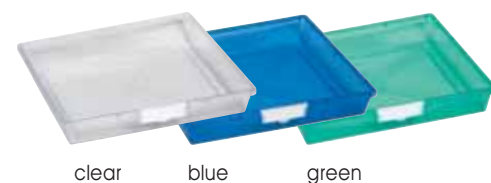

clear blue green

Vista® 180 Action Station Trolley

Designed for "just in time" working during ward rounds, Vista 180 Action Station provides working space for a laptop or "Vital Pack" with a lockable top tray, additional tray storage for patient notes and equipment and is functional, durable and easy to clean.



Double column trolley specifically designed in conjunction with leading Consultant Dr Gordon Caldwell FRCP (London), Consultant Physician, of Worthing Hospital, Diabetes Centre for "just in time" working during ward rounds.

Dr Caldwell comments, "I have found that this trolley significantly improves ward round efficiency, it holds the team of doctors around the trolley and gives them a large surface to write on, the horizontal filing system is also far easier to use than traditional vertical files, we more clearly define team members' roles, therefore more productive doctors".



Code: **Sun-MPT180**
Vista 180 Action Station Trolley
18 single depth trays



Code: **Sun-MPT181**
Vista 180 Action Station Trolley
10 single/4 double depth trays

product information

 Tilt & locking tray runner system	 Upto eight trays	 Trays integrate with all other Vista products	 Single or double depth tray combinations	 Adjustable feet for levelling
 Optional tamper resistant locking door	 Removable top shelf with integrated upstand	 Modules can be attached together to form larger systems	 Optional castor upgrades available	 Durable epoxy coated white frame
 Easy clean design and materials	 2 year warranty	 Supplied fully assembled	 British made	

accessories

* These accessories can only be fitted when ordered with the storage module

 Sun-SMLC2 * 4 Castors (front 2 braked)	 Sun-SMLC3A * 4 Antistatic Castors (front 2 braked)	 Sun-BUF3 * 4 Protective Buffers	 Sun-SMS1/LD */*** Tamper Resistant Locking Door	 Sun-DIV1 Single Depth Tray Dividers (per set)
 Sun-DIV4 Double Depth Tray Dividers (per set)				

*** Locking door option includes a secure top and back panel

dimensions

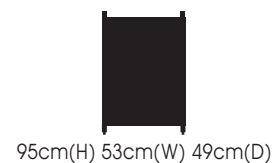

Single Depth Trays
8cm(H) 47cm(W) 42cm(D)
Double Depth Trays
16cm(H) 47cm(W) 42cm(D)

tray colours

please specify when ordering
(Tray labels and covers included)



clear blue green

Modular, flexible and colourful, Vista Low Level Storage Modules provide a general storage solution for healthcare environments, using premium materials which are functional, durable and easy to clean.



Code: Sun-SM1/8
Vista low level module
8 single depth trays



Code: Sun-SM1/4/2D
Vista low level module
4 single/2 double depth trays



Code: Sun-SM1/4D
Vista low level module
4 double depth trays



Code: Sun-SM1/LD
Locking door for Vista
low level module



Modules can be attached together to form larger systems

product information

 Tilt & locking tray runner system	 Upto sixteen trays	 Trays integrate with all other Vista products	 Single or double depth tray combinations	 Adjustable feet for levelling
 Optional tamper resistant locking doors	 Removable top shelf with integrated upstand	 Modules can be attached together to form larger systems	 Optional castor upgrades available	 Durable epoxy coated white frame
 Easy clean design and materials	 2 year warranty	 Supplied fully assembled	 British made	

accessories

* These accessories can only be fitted when ordered with the storage module

 Sun-SMLC2 * 4 Castors (front 2 braked)	 Sun-SMLC3A * 4 Antistatic Castors (front 2 braked)	 Sun-BUF3 * 4 Protective Buffers	 Sun-SMS2/LD */*** 2 Tamper Resistant Locking Doors	 Sun-DIV1 Single Depth Tray Dividers (per set)
 Sun-DIV4 Double Depth Tray Dividers (per set)				

*** Locking door option includes a secure top and back panel

dimensions

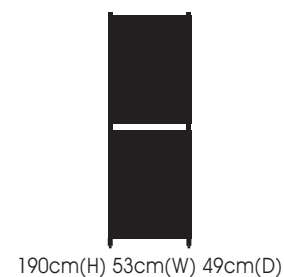

Single Depth Trays
8cm(H) 47cm(W) 42cm(D)
Double Depth Trays
16cm(H) 47cm(W) 42cm(D)

tray colours

please specify when ordering
(Tray labels and covers included)

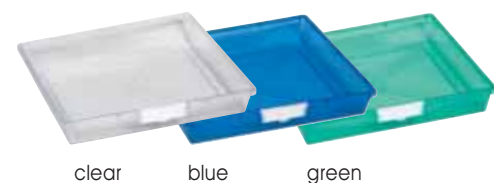

Modular, flexible and colourful, Vista High Level Storage Modules provide optimum storage for general healthcare environments, using premium materials which are functional, durable and easy to clean.



Code: **Sun-SM2/16**
Vista high level module
16 single depth trays



Code: **Sun-SM2/8/4D**
Vista high level module
8 single/4 double depth trays



Code: **Sun-SM2/8D**
Vista high level module
8 double depth trays



Code: **Sun-SM2/LD**
2 locking doors for Vista
high level modules



Modules can be attached
together to form larger systems



product information

 Tilt & locking tray runner system	 Clear, durable, easy to clean ABS plastic trays	 Contemporary door and profile with 'high gloss' finish	 Trays integrate with all other Vista products	 Strong durable 18mm white carcass construction
 Locking doors (2 keys supplied)	 Durable 38mm White postformed worktop (VBU4W & VBU1W)	 One piece removable plinth	 Tray labels and covers included	 Easy clean design and materials
 2 year warranty	 Supplied fully assembled	 British made		

accessories

 Sun-VBU/KEY Extra Keys (each)	 Sun-DIV1 Single Depth Tray Dividers (per set)	 Sun-DIV4 Double Depth Tray Dividers (per set)
---	--	--

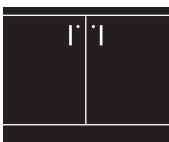
dimensions

 Sun-VBU1W 91cm(H) 51.5cm(W) 60cm(D)	 Sun-VBU4W 91cm(H) 103cm(W) 60cm(D)	 Sun-VLUT1W 161cm(H) 51.5cm(W) 60cm(D)	<p>Single Depth Trays 8cm(H) 47cm(W) 42cm(D)</p> <p>Double Depth Trays 16cm(H) 47cm(W) 42cm(D)</p> <p>HEAVY ITEM</p>
---	--	---	---

Designed to be aesthetically pleasing, accessible and secure, Vista base & larder cabinets provide maximum tray storage for equipment and disposable, using premium materials which are functional, durable and easy to clean.



Code: **Sun-VBU4W**
103cm wide Vista base unit with 38mm white postformed worktop
10 single/2 double depth trays



Code: **Sun-VBU1W**
51.5cm wide Vista base unit with 38mm white postformed worktop
5 single/1 double depth trays







Code: **Sun-VLUT1W**
51.5cm wide Vista larder unit with 18mm white MFC top
7 single/3 double depth trays



hygienic
safe
procedures

Dressing & Surgical Trolleys, Theatre Equipment

Designed for clinical procedures in healthcare environments, our range of trolleys, support surfaces and ancillary equipment can be sterilised, whilst being functional, durable and easy to clean.

	PAGE
 Dressing Trolleys	93-96
 Surgical Trolleys	97-100
 Surgical Trolleys (Mirror Polished)	101-104
 Theatre Equipment	105-106



product information

 Unique glass effect safety trays	 2 or 3 glass effect removable trays	 Lift-off top tray with integral handles	 Hygienically designed raised upstands	 Trays 'locate' around frame to prevent movement
 Tray protection buffer ring	 Durable non-marking 75mm castors	 Durable epoxy coated white frame	 Optional drawers available in a choice of 4 finishes	 4 Drawer finishes
 Maximum individual tray load	 Easy clean design and materials	 2 year warranty	 Supplied fully assembled	 British made



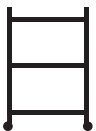

accessories * These accessories can only be fitted when ordered with the trolley

 Sun-DT4D* Single Drawer Unit (small trolleys)	 Sun-DTDT1 Drawer insert for small trolley drawer (each)	 Sun-DT6D* Single Drawer Unit (medium trolleys)	 Sun-DTDT2 Drawer insert for medium trolley drawer (each)	 Sun-DT8D* Double Drawer Unit (large trolleys)
 Sun-DTDT3 Drawer insert for large trolley drawer (each)	 Sun-BUF1* 4 Protective buffers	 Sun-LC1* 2 front braked castors	 Sun-LC1A* 4 Antistatic castors (front 2 braked)	

dimensions

small  86cm(H) 46cm(W) 52cm(D)	medium  86cm(H) 66cm(W) 52cm(D)	large  86cm(H) 86cm(W) 52cm(D)
---	--	---

drawer finishes - please specify when ordering

 White (high gloss)	 Titanium (high gloss)	 Beech effect	 Maple effect
---	--	---	--

Dressing Trolleys - Glass Effect Safety Trays

Innovative in design, and in use of materials, our range of dressing trolleys provide hygienic mobile support and storage, whilst being functional, durable and easy to clean.

small - 46cm wide dressing trolleys

 Code: Sun-DT4G2 2 glass effect safety trays	 Code: Sun-DT4G3 3 glass effect safety trays	 Sun-DT4G3 with optional Sun-DT4D single drawer unit
--	--	--

medium - 66cm wide dressing trolleys

 Code: Sun-DT6G2 2 glass effect safety trays	 Code: Sun-DT6G3 3 glass effect safety trays	 Sun-DT6G3 with optional Sun-DT6D single drawer unit
--	--	--

large - 86cm wide dressing trolleys



 Code: Sun-DT8G2 2 glass effect safety trays	 Code: Sun-DT8G3 3 glass effect safety trays	 Sun-DT8G3 with optional Sun-DT8D double drawer unit
--	--	--





product information

 Stainless steel trays (304 grade/DP2 finish)	 2 or 3 stainless steel removable trays	 Lift-off top tray with integral handles	 Hygienically designed raised upstands	 Trays 'locate' around frame to prevent movement
 Tray protection buffer ring	 Durable non-marking 75mm castors	 Durable epoxy coated white frame	 Optional drawers available in a choice of 4 finishes	 4 Drawer finishes
 Maximum individual tray load	 Easy clean design and materials	 2 year warranty	 Supplied fully assembled	 British made

accessories * These accessories can only be fitted when ordered with the trolley

 Sun-DT4D* Single Drawer Unit (small trolleys)	 Sun-DTDT1 Drawer insert for small trolley drawer (each)	 Sun-DT6D* Single Drawer Unit (medium trolleys)	 Sun-DTDT2 Drawer insert for medium trolley drawer (each)	 Sun-DT8D* Double Drawer Unit (large trolleys)
 Sun-DTDT3 Drawer insert for large trolley drawer (each)	 Sun-BUF1* 4 Protective buffers	 Sun-LC1* 2 front braked castors	 Sun-LC1A* 4 Antistatic castors (front 2 braked)	

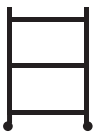
dimensions

small  86cm(H) 46cm(W) 52cm(D)	medium  86cm(H) 66cm(W) 52cm(D)	large  86cm(H) 86cm(W) 52cm(D)
---	--	---

drawer finishes - please specify when ordering

 White (high gloss)	 Titanium (high gloss)	 Beech effect	 Maple effect
---	--	---	--

Dressing Trolleys - Stainless Steel Trays

Innovative in design, and in use of materials, our range of dressing trolleys provide hygienic mobile support and storage, whilst being functional, durable and easy to clean.

small - 46cm wide dressing trolleys

 Code: Sun-DT4S2 2 stainless steel trays	 Code: Sun-DT4S3 3 stainless steel trays	 Sun-DT4S3 with optional Sun-DT4D single drawer unit
--	--	---

medium - 66cm wide dressing trolleys

 Code: Sun-DT6S2 2 stainless steel trays	 Code: Sun-DT6S3 3 stainless steel trays	 Sun-DT6S3 with optional Sun-DT6D single drawer unit
--	--	---

large - 86cm wide dressing trolleys

 Code: Sun-DT8S2 2 stainless steel trays	 Code: Sun-DT8S3 3 stainless steel trays	 Sun-DT8S3 with optional Sun-DT8D double drawer unit
--	--	---



product information



Stainless steel trays (304 grade/DP2 finish)



2 or 3 stainless steel removable trays



Lift-off top tray with integral handles



Hygienically designed raised upstands



Trays 'locate' around frame to prevent movement



Tray protection buffer ring



Durable non-marking 75mm castors



Polished stainless steel frame (304 grade)



Maximum individual tray load



Easy clean design and materials



2 year warranty



Supplied fully assembled



British made

accessories

* These accessories can only be fitted when ordered with the trolley



Sun-BUF1*
4 Protective buffers



Sun-LC1*
2 front braked castors



Sun-LC1A*
4 Antistatic castors (front 2 braked)

dimensions

small



86cm(H) 46cm(W) 52cm(D)

medium



86cm(H) 66cm(W) 52cm(D)

large



86cm(H) 86cm(W) 52cm(D)

Surgical Trolleys - Stainless Steel Trays

Innovative in design, and in use of materials, our range of surgical trolleys provide hygienic mobile support for clinical environments, whilst being functional, durable and easy to clean.

small - 46cm wide surgical trolleys



Code: Sun-ST4S2
2 stainless steel trays



Code: Sun-ST4S3
3 stainless steel trays

medium - 66cm wide surgical trolleys



Code: Sun-ST6S2
2 stainless steel trays



Code: Sun-ST6S3
3 stainless steel trays

large - 86cm wide surgical trolleys









Code: Sun-ST8S2
2 stainless steel trays



Code: Sun-ST8S3
3 stainless steel trays



product information

 Removable stainless steel shelf (304 grade/DP2 finish))	 Lift-off stainless steel trays (304 grade/DP2 finish)	 2 or 3 stainless steel shelf/tray combinations	 Shelves & trays 'locate' around frame to prevent movement	 Shelf/tray protection buffer ring
 Durable non-marking 75mm castors	 Polished stainless steel frame (304 grade)	 Maximum individual tray load	 Easy clean design and materials	 Supplied fully assembled
 Supplied fully assembled	 British made			

accessories * These accessories can only be fitted when ordered with the trolley

 Sun-BUF1* 4 Protective buffers	 Sun-LC1* 2 front braked castors	 Sun-LC1A* 4 Antistatic castors (front 2 braked)
---	--	--

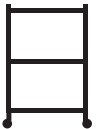
dimensions

small  86cm(H) 46cm(W) 52cm(D)	medium  86cm(H) 66cm(W) 52cm(D)	large  86cm(H) 86cm(W) 52cm(D)
---	--	---

Surgical Trolleys - Stainless Steel Flat Top Shelf & Trays

Innovative in design, and in use of materials, our range of surgical trolleys provide hygienic mobile support for clinical environments, whilst being functional, durable and easy to clean.

small - 46cm wide surgical trolleys



Code: **Sun-ST4S2SF**
1 stainless steel shelf and 1 tray



Code: **Sun-ST4S3SF**
1 stainless steel shelf and 2 trays

medium - 66cm wide surgical trolleys



Code: **Sun-ST6S2SF**
1 stainless steel shelf and 1 tray



Code: **Sun-ST6S3SF**
1 stainless steel shelf and 2 trays

large - 86cm wide surgical trolleys



Code: **Sun-ST8S2SF**
1 stainless steel shelf and 1 tray



Code: **Sun-ST8S3SF**
1 stainless steel shelf and 2 trays

product information

premium quality Stainless steel shelves, trays and frame (304 grade)	 Mirror polished stainless steel shelves, trays and frame	 Fully welded seamless frame	 BS 4068 : 1977 Compliant *	3 shelf options Flat, fixed or removable/reversible shelves
 Mirror polished lift off flat shelves (Sun-STFW/RFS2 only)	 Removable, reversible folded shelves (Sun-STFW/RRFS2 only)	 Fully welded fixed shelves (Sun-STFW/FFS2 only)	 Anti-static shelf/tray protection buffers	 75mm antistatic castors
 4 Protective buffers	10Kg Maximum individual tray load	 Easy clean design and materials	 2 year warranty	 Supplied fully assembled



* Designed to comply with the requirements of the hospital market (BS4068: 1977)

accessories * These accessories can only be fitted when ordered with the trolley

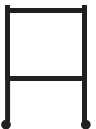

Sun-LC1A*
4 Antistatic castors (front 2 braked)

dimensions

small  86cm(H) 45cm(W) 45cm(D) 53cm(W) 53cm(D) with buffers	medium  86cm(H) 61cm(W) 45cm(D) 69cm(W) 53cm(D) with buffers
--	---

Premium use of materials, and finished to the highest standard, our range of 'mirror polished' surgical trolleys provide hygienic mobile support for clinical environments and theatres, whilst being functional, durable and easy to clean.

small - 45cm wide surgical trolleys (mirror polished)



Code: **Sun-STFW4/RFS2**
2 removable flat shelves



Code: **Sun-STFW4/RRFS2**
2 removable reversible folded shelves (flange up or down)



Code: **Sun-STFW4/FFS2**
2 fully welded fixed shelves (flange down)

medium - 61cm wide surgical trolleys (mirror polished)



Code: **Sun-STFW6/RFS2**
2 removable flat shelves



Code: **Sun-STFW6/RRFS2**
2 removable reversible folded shelves (flange up or down)



Code: **Sun-STFW6/FFS2**
2 fully welded fixed shelves (flange down)

product information

premium quality Stainless steel shelves, trays and frame (304 grade)	 Mirror polished stainless steel shelves, trays and frame	 Fully welded seamless frame	 BS 4068 : 1977 Compliant *	3 shelf options Flat, fixed or removable/reversible shelves
 Mirror polished lift off flat shelves (Sun-STFW/RFS2 only)	 Removable, reversible folded shelves (Sun-STFW/RRFS2 only)	 Fully welded fixed shelves (Sun-STFW/FFS2 only)	 Anti-static shelf/tray protection buffers	 75mm antistatic castors
 4 Protective buffers	10Kg Maximum individual tray load	 Easy clean design and materials	 2 year warranty	 Supplied fully assembled

* Designed to comply with the requirements of the hospital market (BS4068: 1977)

accessories * These accessories can only be fitted when ordered with the trolley



Sun-LC1A*
4 Antistatic castors (front 2 braked)

dimension

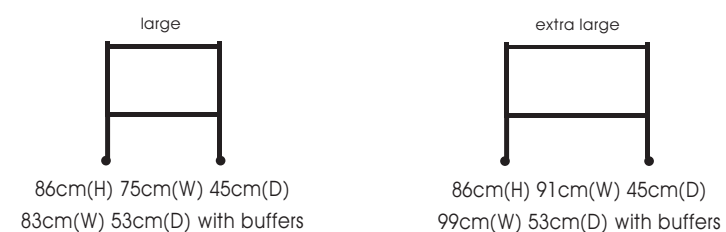

Premium use of materials, and finished to the highest standard, our range of 'mirror polished' surgical trolleys provide hygienic mobile support for clinical environments and theatres, whilst being functional, durable and easy to clean.

large - 75cm wide surgical trolleys (mirror polished)

extra large - 91cm wide surgical trolleys (mirror polished)



Code: **Sun-STFW7/RFS2**
2 removable flat shelves



Code: **Sun-STFW9/RFS2**
2 removable flat shelves



Code: **Sun-STFW7/RRFS2**
2 removable reversible folded shelves (flange up or down)



Code: **Sun-STFW9/RRFS2**
2 removable reversible folded shelves (flange up or down)



Code: **Sun-STFW7/FFS2**
2 fully welded fixed shelves (flange down)









Code: **Sun-STFW9/FFS2**
2 fully welded fixed shelves (flange down)

product information

 Premium quality (304 grade) stainless steel	 Fully welded seamless frame	 Polished (304 grade) stainless steel bowls, trays and buckets	 HEIGHT RANGE 72-108cm Adjustable height bowl stands (Sun-TBSV01/02 only)	 HEIGHT RANGE 74-112cm Adjustable height mayo tables (Sun-TMAY02 only)
 Five castor base for stability and manoeuvrability	 Removable bowls	 Removable spiral bowl and bucket buffers	 Removable bucket with handle (18 litre capacity)	 Removable stainless steel instrument tray
 Height adjustment locking handle	 50mm antistatic castors	 eze Easy clean design and materials	 2 year warranty	 Supplied fully assembled

dimensions

 77cm - 108cm(H) 58cm(W) 58cm(D) Bowl 31cm Ø - 9cm(H)	 77cm - 108cm(H) 74cm(W) 58cm(D) Bowls 31cm Ø - 9cm(H)	 85cm(H) 45cm(W) 45cm(D) Bowls 31cm Ø - 9cm(H)	 85cm(H) 75cm(W) 39cm(D) Bowls 31cm Ø - 9cm(H)
 74cm - 112cm(H) 67cm(W) 47cm(D) Tray 2cm(H) 47cm(W) 36cm(D)	 52cm(H) 38cm(W) 38cm(D) Bucket 29cm Ø - 28cm(H) 18 Litre capacity	 19cm(H) 31cm(W) 31cm(D) Bowl 31cm Ø - 9cm(H)	

Premium use of materials, and finished to the highest standard, our range of polished stainless steel theatre equipment provide hygienic mobile support and solutions for clinical environments and theatres, whilst being functional, durable and easy to clean.



Code: **Sun-TBSV01**
Single variable height bowl stand with bowl



Code: **Sun-TBSV02**
Double variable height bowl stand with 2 bowls



Code: **Sun-TBSF01**
Two tier double bowl stand with 2 bowls



Code: **Sun-TBSF02**
Side by side double bowl stand with 2 bowls



Code: **Sun-TMAY02**
Mayo table, adjustable height with 4 castors



Code: **Sun-TBKS01**
Bucket stand with bucket 18 litre capacity









Code: **Sun-TKAB01**
Kickabout stand with bowl

strong
secure
protection

Medicine & Controlled Drug Cabinets

Professionally designed and independently tested for your peace of mind, we provide secure storage solutions for most types of medicines and pharmaceuticals including the latest innovative BIDOSE system.

	PAGE
 Medicine Cabinets	108-111
 Controlled Drug Cabinets	112-115
 Medicine Cabinets with Controlled Drug Inner Cabinets	116-121
 MDS Medicine Cabinets	122-123
 Self Administration Cabinets	122-123
 BIDOSE Medicine Cabinets	124-125

product information



Independently tested



BS 2881:1989 Security Level 1 compliant



High security 8 lever lock designed to EN1300 and Vds 2396



Anti-pick levers & deadlock mechanism



3 keys supplied (per lock) Extra keys available



Protective key escutcheon



Adjustable shelves and door trays



Internal door retaining flange



Durable and hygienic white epoxy coating



Single door cabinets are right hand hinged (left hand optional)



Optional warning light and buzzer alarm



Easy clean design and materials



2 year warranty



Supplied fully assembled



British made



Delivery normally within 3-5 working days* (Sun-MC1, MC2 & MC3 only)

* Please contact us regarding availability for quantities of 10 or more.

accessories

* Factory fit - only available at time of ordering cabinet



Sun-MC/LIGHT1 *
(For Sun-MC1/MC2/MC3 Cabinets)
Sun-MC/LIGHT2 *
(For Sun-MC6/MC7 Cabinets)



Sun-MC/BUZZ *
Buzzer alarm (has to be combined with Sun-MC/Light)



Sun-MC/LHH *
Left hand hinge option



Sun-MC/KEY *
Additional key (when ordered with cabinet)

5V DC external warning light shows green when closed, red when open and flashes red when left open for 2.5 minutes. Nurse call output, (volt free contact) for connection to nurse call system. Internal illumination when door is opened. Must be hard wired to a 220/240V AC mains supply. Buzzer alarm activates when cabinet is left open for 5 minutes (only available when combined with optional warning light)

dimensions

- NB: Optional warning light transformer box adds 55mm to overall height



MC1	MC2	MC3	MC6	MC7
60cm(H)	60cm(H)	60cm(H)	85cm(H)	85cm(H)
30cm(W)	50cm(W)	60cm(W)	50cm(W)	60cm(W)
30cm(D)	30cm(D)	30cm(D)	30cm(D)	30cm(D)

Independently tested to conform to or exceed all the required standards and legislation, all our medicine cabinets provide secure storage, which can be adapted internally to your exact requirements.



Code: **Sun-MC1**
Medicine cabinet with 3 shelves, 2 door trays, shown with optional warning light



Code: **Sun-MC2**
Medicine cabinet with 3 shelves, 2 door trays, shown with optional warning light



Code: **Sun-MC3**
Medicine cabinet with 3 shelves, 2 door trays, shown with optional warning light



Code: **Sun-MC6**
Medicine cabinet with 4 shelves, 4 door trays, shown with optional warning light



Code: **Sun-MC7**
Medicine cabinet with 4 shelves, 4 door trays, shown with optional warning light



product information



Independently tested



BS 2881:1989
Security Level 1
compliant



High security 8 lever
lock designed to
EN1300 and Vds 2396



Anti-pick levers &
deadlock mechanism



3 keys supplied
(per lock)
Extra keys available



Protective key
escutcheon



Adjustable shelves and
door trays



Internal door
retaining flange



Durable and hygienic
white epoxy coating



Single door cabinets
are right hand hinged
(left hand optional)



Optional warning light
and buzzer alarm



Easy clean design
and materials



2 year warranty



Supplied fully
assembled



British made

accessories * Factory fit - only available at time of ordering cabinet

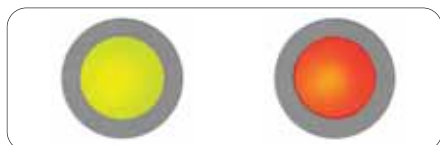

Sun-MC/LIGHT3 *
(For Sun-MC4/MC5/MC8/MC9 Cabinets)



Sun-MC/BUZZ *
Buzzer alarm (has to
be combined with
Sun-MC/Light)



Sun-MC/KEY *
Additional key
(when ordered
with cabinet)

5V DC external warning light shows green when closed, red when open and flashes red when left open for 2.5 minutes. Nurse call output, (volt free contact) for connection to nurse call system. Internal illumination when door is opened. Must be hard wired to a 220/240V AC mains supply. Buzzer alarm activates when cabinet is left open for 5 minutes (only available when combined with optional warning light)

dimensions - NB: Optional warning light transformer box adds 55mm to overall height



60cm(H)
80cm(W)
30cm(D)



60cm(H)
100cm(W)
30cm(D)

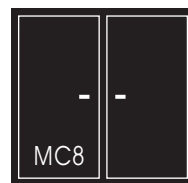

85cm(H)
80cm(W)
30cm(D)



85cm(H)
100cm(W)
30cm(D)

Independently tested to conform to or exceed all the required standards and legislation, all our medicine cabinets provide secure storage, which can be adapted internally to your exact requirements.



Code: **Sun-MC4**
Medicine cabinet with 6 shelves, 4 door trays,
shown with optional warning light



Code: **Sun-MC5**
Medicine cabinet with 6 shelves, 4 door trays,
shown with optional warning light



Code: **Sun-MC8**
Medicine cabinet with 8 shelves, 8 door trays,
shown with optional warning light







Code: **Sun-MC9**
Medicine cabinet with 8 shelves, 8 door trays,
shown with optional warning light



product information





 Independently tested	 Meets the Misuse of Drugs (Safe Custody Regulation 1973)	 BS 2881:1989 Security Level 1 compliant	 High security 8 lever lock designed to EN1300 and Vds 2396	 Anti-pick levers & deadlock mechanism
 3 keys supplied (per lock) Extra keys available	 Protective key escutcheon	 Adjustable shelves and door trays	 Internal door retaining flange	 Durable and hygienic white epoxy coating
 Single door cabinets are right hand hinged (left hand optional)	 Optional warning light and buzzer alarm	 Easy clean design and materials	 2 year warranty	 Supplied fully assembled
 British made	 Delivery normally within 3-5 working days * (Sun-CDC21, 22 & 23 only)	* Please contact us regarding availability for quantities of 10 or more.		

accessories * Factory fit - only available at time of ordering cabinet

 Sun-CDC/LIGHT1 * (For Sun-CDC21/CDC22/CDC23 Cabinets)	 Sun-CDC/LIGHT2 * (For Sun-CDC24/CDC25 Cabinets)	 Sun-CDC/BUZZ * Buzzer alarm (has to be combined with Sun-CDC/Light)	 Sun-CDC/LHH * Left hand hinge option	 Sun-CDC/KEY * Additional key (when ordered with cabinet)
--	--	--	---	--

5V DC external warning light shows green when closed, red when open and flashes red when left open for 2.5 minutes. Nurse call output, (volt free contact) for connection to nurse call system. Internal illumination when door is opened. Must be hard wired to a 220/240V AC mains supply. Buzzer alarm activates when cabinet is left open for 5 minutes (only available when combined with optional warning light)

dimensions - NB: Optional warning light transformer box adds 55mm to overall height

 CDC21	 CDC22	 CDC23	 CDC24	 CDC25
30cm(H) 21cm(W) 27cm(D)	30cm(H) 34cm(W) 27cm(D)	55cm(H) 34cm(W) 27cm(D)	55cm(H) 50cm(W) 30cm(D)	60cm(H) 60cm(W) 30cm(D)

Independently tested to conform to or exceed all the required standards and legislation, all our controlled drug cabinets provide secure storage, which can be adapted internally to your exact requirements.

 Code: Sun-CDC21 Controlled drug cabinet with 1 shelf	 Code: Sun-CDC22 Controlled drug cabinet with 1 shelf and 1 door tray, shown with optional warning light
 Code: Sun-CDC23 Controlled drug cabinet with 2 shelves and 2 door trays, shown with optional warning light	 Code: Sun-CDC24 Controlled drug cabinet with 2 shelves and 2 door trays, shown with optional warning light
 Code: Sun-CDC25 Controlled drug cabinet with 2 shelves, 2 door trays and 2 locks, shown with optional warning light	

Code: Sun-CDC23

product information



Independently tested

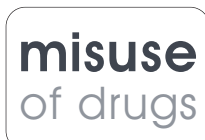

Meets the Misuse of Drugs (Safe Custody Regulation 1973)



BS 2881:1989 Security Level 1 compliant



High security 8 lever lock designed to EN1300 and Vds 2396



Anti-pick levers & deadlock mechanism



3 keys supplied (per lock)
Extra keys available



Protective key escutcheon



Adjustable shelves and door trays



Internal door retaining flange



Durable and hygienic white epoxy coating



Single door cabinets are right hand hinged (left hand optional)

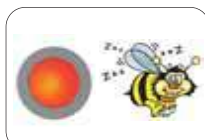

Optional warning light and buzzer alarm



Easy clean design and materials



2 year warranty



Supplied fully assembled



British made

accessories * Factory fit - only available at time of ordering cabinet



Sun-CDC/LIGHT2 *
(For Sun-CDC26/CDC28 Cabinets)
Sun-CDC/LIGHT3 *
(For Sun-CDC27 Cabinet)



Sun-CDC/BUZZ *
Buzzer alarm (has to be combined with Sun-CDC/Light)



Sun-CDC/LHH *
Left hand hinge option



Sun-CDC/KEY *
Additional key (when ordered with cabinet)

5V DC external warning light shows green when closed, red when open and flashes red when left open for 2.5 minutes. Nurse call output, (volt free contact) for connection to nurse call system. Internal illumination when door is opened. Must be hard wired to a 220/240V AC mains supply. Buzzer alarm activates when cabinet is left open for 5 minutes (only available when combined with optional warning light)

dimensions - NB: Optional warning light transformer box adds 55mm to overall height

CDC26



85cm(H)
50cm(W)
30cm(D)

CDC27

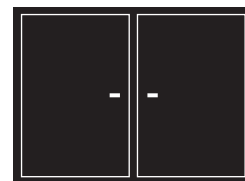

85cm(H)
100cm(W)
30cm(D)

CDC28

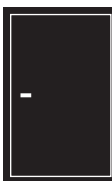

85cm(H)
50cm(W)
45cm(D)

Independently tested to conform to or exceed all the required standards and legislation, all our controlled drug cabinets provide secure storage, which can be adapted internally to your exact requirements.



Code: **Sun-CDC26**
Controlled drug cabinet with 4 shelves and 4 door trays, shown with optional warning light



Code: **Sun-CDC28**
Controlled drug cabinet with 4 shelves and 4 door trays, shown with optional warning light





Code: **Sun-CDC27**
Controlled drug cabinet with 8 shelves and 8 door trays, shown with optional warning light



product information







 Independently tested	 Meets the Misuse of Drugs (Safe Custody Regulation 1973)	 BS 2881:1989 Security Level 1 compliant	 High security 8 lever lock designed to EN1300 and Vds 2396	 Anti-pick levers & deadlock mechanism
 3 keys supplied (per lock) Extra keys available	 Protective key escutcheon on outer cabinet	 5V External warning light is green when closed, red when open - fitted as standard on outer medicine cabinet	 Optional buzzer alarm	
 Adjustable shelves and door trays	 Identification coloured key fobs	 Identification key escutcheon on inner cabinet	 Internal door retaining flange	 Durable and hygienic white epoxy coating
 Single door cabinets are right hand hinged (left hand optional)	 Easy clean design and materials	 2 year warranty	 Supplied fully assembled	 British made

accessories * Factory fit - only available at time of ordering cabinet

 Sun-MC/BUZZ * Buzzer alarm	 Sun-MC/LHH * Left hand hinge option	 Sun-MC/KEY * Additional key for outer cabinet (when ordered with cabinet)	 Sun-CDC/KEY * Additional key for controlled drug inner cabinet (when ordered with cabinet)
--	---	---	--

Warning Light (fitted as standard)
5V DC external warning light shows green when closed, red when open and flashes red when left open for 2.5 minutes. Nurse call output, (volt free contact) for connection to nurse call system. Internal illumination when door is opened. Must be hard wired to a 220/240V AC mains supply. Buzzer alarm activates when cabinet is left open for 5 minutes (only available when combined with optional warning light)

dimensions - NB: Height measurement for outer cabinets includes transformer box

Controlled Drug Inner Cabinets			Medicine Outer Cabinets			
CDC21	CDC22	CDC23	MC2	MC3	MC6	MC7
						
30cm(H) 21cm(W) 27cm(D)	30cm(H) 34cm(W) 27cm(D)	55cm(H) 34cm(W) 27cm(D)	66cm(H) 50cm(W) 30cm(D)	66cm(H) 60cm(W) 30cm(D)	91cm(H) 50cm(W) 30cm(D)	91cm(H) 60cm(W) 30cm(D)

Independently tested to conform to or exceed all the required standards and legislation. Our range of combined medicine and drug cabinets provide secure storage, which can be adapted internally to your exact requirements. A warning light and buzzer provide additional security.



CODE: Sun-MCDC221
MC2 Medicine outer cabinet combined with CDC21 controlled drugs inner cabinet



CODE: Sun-MCDC321
MC3 Medicine outer cabinet combined with CDC21 controlled drugs inner cabinet



CODE: Sun-MCDC322
MC3 Medicine outer cabinet combined with CDC22 controlled drugs inner cabinet



CODE: Sun-MCDC621
MC6 Medicine outer cabinet combined with CDC21 controlled drugs inner cabinet



CODE: Sun-MCDC722
MC7 Medicine outer cabinet combined with CDC22 controlled drugs inner cabinet





CODE: Sun-MCDC723
MC7 Medicine outer cabinet combined with CDC23 controlled drugs inner cabinet

product information





 Independently tested	 Meets the Misuse of Drugs (Safe Custody Regulation 1973)	 BS 2881:1989 Security Level 1 compliant	 High security 8 lever lock designed to EN1300 and Vds 2396	 Anti-pick levers & deadlock mechanism
 3 keys supplied (per lock) Extra keys available	 Protective key escutcheon on outer cabinet	 5V External warning light is green when closed, red when open - fitted as standard on outer medicine cabinet	 Optional buzzer alarm	
 Adjustable shelves and door trays	 Identification coloured key fobs	 Identification key escutcheon on inner cabinet	 Internal door retaining flange	 Durable and hygienic white epoxy coating
 Easy clean design and materials	 2 year warranty	 Supplied fully assembled	 British made	

accessories * Factory fit - only available at time of ordering cabinet

 Sun-MC/BUZZ * Buzzer alarm	 Sun-MC/KEY * Additional key for outer cabinet (when ordered with cabinet)	 Sun-CDC/KEY * Additional key for controlled drug inner cabinet (when ordered with cabinet)
---	--	---

Warning Light (fitted as standard)
5V DC external warning light shows green when closed, red when open and flashes red when left open for 2.5 minutes. Nurse call output, (volt free contact) for connection to nurse call system. Internal illumination when door is opened. Must be hard wired to a 220/240V AC mains supply. Buzzer alarm activates when cabinet is left open for 5 minutes (only available when combined with optional warning light)

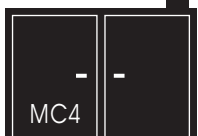
dimensions - NB: Height measurement for outer cabinets includes transformer box

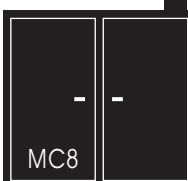
Controlled Drug Inner Cabinets			Medicine Outer Cabinets		
CDC21	CDC22	CDC23	MC4	MC5	MC8
					
30cm(H) 21cm(W) 27cm(D)	30cm(H) 34cm(W) 27cm(D)	55cm(H) 34cm(W) 27cm(D)	66cm(H) 80cm(W) 30cm(D)	66cm(H) 100cm(W) 30cm(D)	91cm(H) 80cm(W) 30cm(D)

Independently tested to conform to or exceed all the required standards and legislation. Our range of combined medicine and drug cabinets provide secure storage, which can be adapted internally to your exact requirements. A warning light and buzzer provide additional security.



CODE: **Sun-MCDC421**
MC4 Medicine outer cabinet combined with CDC21 controlled drugs inner cabinet



CODE: **Sun-MCDC521**
MC5 Medicine outer cabinet combined with CDC21 controlled drugs inner cabinet



CODE: **Sun-MCDC522**
MC5 Medicine outer cabinet combined with CDC22 controlled drugs inner cabinet





CODE: **Sun-MCDC821**
MC8 Medicine outer cabinet combined with CDC21 controlled drugs inner cabinet

product information

 Independently tested	 Meets the Misuse of Drugs (Safe Custody Regulation 1973)	 BS 2881:1989 Security Level 1 compliant	 High security 8 lever lock designed to EN1300 and Vds 2396	 Anti-pick levers & deadlock mechanism
 3 keys supplied (per lock) Extra keys available	 Protective key escutcheon on outer cabinet	 5V External warning light is green when closed, red when open - fitted as standard on outer medicine cabinet	 Optional buzzer alarm	
 Adjustable shelves and door trays	 Identification coloured key fobs	 Identification key escutcheon on inner cabinet	 Internal door retaining flange	 Durable and hygienic white epoxy coating
 Easy clean design and materials	 2 year warranty	 Supplied fully assembled	 British made	





accessories * Factory fit - only available at time of ordering cabinet

 Sun-MC/BUZZ * Buzzer alarm	 Sun-MC/KEY * Additional key for outer cabinet (when ordered with cabinet)	 Sun-CDC/KEY * Additional key for controlled drug inner cabinet (when ordered with cabinet)
---	--	---

Warning Light (fitted as standard)
5V DC external warning light shows green when closed, red when open and flashes red when left open for 2.5 minutes. Nurse call output, (volt free contact) for connection to nurse call system. Internal illumination when door is opened. Must be hard wired to a 220/240V AC mains supply. Buzzer alarm activates when cabinet is left open for 5 minutes (only available when combined with optional warning light)

dimensions - NB: Height measurement for outer cabinets includes transformer box

Controlled Drug Inner Cabinets

 CDC21	 CDC22	 CDC23	 MC9
30cm(H) 21cm(W) 27cm(D)	30cm(H) 34cm(W) 27cm(D)	55cm(H) 34cm(W) 27cm(D)	91cm(H) 100cm(W) 30cm(D)

Independently tested to conform to or exceed all the required standards and legislation. Our range of combined medicine and drug cabinets provide secure storage, which can be adapted internally to your exact requirements. A warning light and buzzer provide additional security.



CODE: **Sun-MCDC921**
MC9 Medicine outer cabinet combined with CDC21 controlled drugs inner cabinet





CODE: **Sun-MCDC922**
MC9 Medicine outer cabinet combined with CDC22 controlled drugs inner cabinet



CODE: **Sun-MCDC923**
MC9 Medicine outer cabinet combined with CDC23 controlled drugs inner cabinet

product information











 Independently tested by FIRA	 BS 2881:1989 Security Level 1 compliant	 High security 8 lever lock designed to EN1300 and Vds 2396	 Anti-pick levers & deadlock mechanism	 3 keys supplied (per lock) Extra keys available
 Protective key escutcheon	 Integral brackets for hanging MDS racks	 Internal door retaining flange	 Durable and hygienic white epoxy coating	 Single door cabinets are right hand hinged (left hand optional)
 Optional warning light and buzzer alarm	 Easy clean design and materials	 2 year warranty	 Supplied fully assembled	 British made

accessories * Factory fit - only available at time of ordering cabinet

 Sun-MC/LIGHT1 * (For Sun-MC1/MC2/MC3 Cabinets)	 Sun-MC/LIGHT2 * (For Sun-MC6/MC7 Cabinets)	 Sun-MC/LIGHT3 * (For Sun-MC4/MC5/MC8/MC9 Cabinets)	 Sun-MC/BUZZ * Buzzer alarm (has to be combined with Sun-MC/Light)	 Sun-MC/LHH * Left hand hinge option	 Sun-MC/KEY * Additional key (when ordered with cabinet)
---	---	---	--	--	--

5V DC external warning light shows green when closed, red when open and flashes red when left open for 2.5 minutes. Nurse call output, (volt free contact) for connection to nurse call system. Internal illumination when door is opened. Must be hard wired to a 220/240V AC mains supply. Buzzer alarm activates when cabinet is left open for 5 minutes (only available when combined with optional warning light)

dimensions - NB: Optional warning light transformer box adds 55mm to overall height

 60cm(H) 30cm(W) 30cm(D)	 60cm(H) 50cm(W) 30cm(D)	 60cm(H) 60cm(W) 30cm(D)	 60cm(H) 80cm(W) 30cm(D)	 60cm(H) 100cm(W) 30cm(D)
 85cm(H) 50cm(W) 30cm(D)	 85cm(H) 60cm(W) 30cm(D)	 85cm(H) 80cm(W) 30cm(D)	 85cm(H) 100cm(W) 30cm(D)	 42cm(H) 30cm(W) 24cm(D)
				 72cm(H) 40cm(W) 24cm(D)

Independently tested to conform to or exceed all the required standards and legislation, our range of Monitored Dosage System (MDS) cabinets provide secure storage, and designed for nursing and care homes using the Manrex (Boots) and Venalink systems.



Code: **Sun-MC1/MDS1** Medicine cabinet with 1 MDS rack
Code: **Sun-MC2/MDS2** Medicine cabinet with 2 MDS racks
Code: **Sun-MC3/MDS2** Medicine cabinet with 2 MDS racks
Code: **Sun-MC6/MDS4** Medicine cabinet with 4 MDS racks
Code: **Sun-MC7/MDS4** Medicine cabinet with 4 MDS racks
(shown with optional warning light & left hand hinge option)



Code: **Sun-MC4/MDS2** Medicine cabinet with 2 MDS racks
Code: **Sun-MC5/MDS4** Medicine cabinet with 4 MDS racks
Code: **Sun-MC8/MDS4** Medicine cabinet with 4 MDS racks
Code: **Sun-MC9/MDS8** Medicine cabinet with 8 MDS racks
(shown with optional warning light)

Self-Administration Cabinets

Designed for storage of self administration medicines, our cabinets provide low level security for the Monitored Dosage System (MDS) and are suitable for storing the Manrex (Boots) and Venalink systems. Optional keyed to differ available.



Code: **Sun-MDSCAB1**
Code: **Sun-MDSCAB1/KD (keyed to differ)**
Self administration MDS beech effect locking wall cabinet with 1 shelf & 1 rack bracket (supplied with 2 keys)



Code: **Sun-MDSCAB2**
Code: **Sun-MDSCAB2/KD (keyed to differ)**
Self administration MDS beech effect locking wall cabinet with 1 shelf & 2 rack brackets (supplied with 2 keys)







Delivery normally within 3-5 working days *

* Please contact us regarding availability for quantities of 10 or more.

product information - BODOSE medicine cabinets

 Independently tested by FIRA	 Cabinets store 15 or 30 BODOSE trays	 BS 2881:1989 Security Level 1 compliant	 Individual tray slots with easy access	 Protective key escutcheon
 High security 8 lever lock designed to EN1300 and Vds 2396	 Anti-pick levers & deadlock mechanism	 3 keys supplied (per lock) Extra keys available	 Internal door retaining flange	 Mild steel with hygienic white epoxy coating

product information - BODOSE self administration medicine cabinets

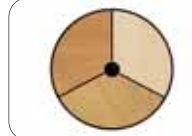



 Holds 6 BODOSE trays	 Individual tray slots with easy access	 Lock provided with 2 keys	 Mild steel with hygienic white epoxy coating (Sun-BIO/SA6 only)	 Oak, beech or maple effect finishes
---	---	--	--	--

additional product information

 Easy clean design and materials	 2 year warranty	 Supplied fully assembled	 British made
--	--	---	---

accessories (only available for Sun-BIO/MC15 & Sun-BIO/MC30 cabinets)

* Factory fit - only available at time of ordering cabinet

 Sun-BIO/MC/LIGHT* External Warning Light (see below)	 Sun-BIO/MC/BUZZ* Buzzer Alarm (has to be combined with warning light)	 Sun-BIO/MC/KEY* Additional key (when ordered with cabinet)	 BIODOSE Drug Trolley Range (see pages 221-222)
--	---	--	--

5V DC external warning light shows green when closed, red when open and flashes red when left open for 2.5 minutes. Nurse call output, (volt free contact) for connection to nurse call system. Internal illumination when door is opened. Must be hard wired to a 220/240V AC mains supply. Buzzer alarm activates when cabinet is left open for 5 minutes (only available when combined with optional warning light)

dimensions - NB: Optional warning light transformer box adds 55mm to overall height

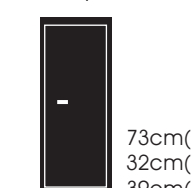
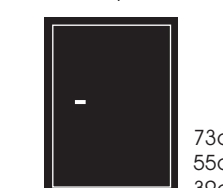
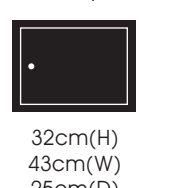
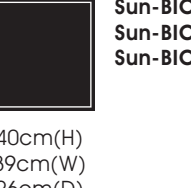
 Sun-BIO/MC15 73cm(H) 32cm(W) 39cm(D)	 Sun-BIO/MC30 73cm(H) 55cm(W) 39cm(D)	 Sun-BIO/SA6 32cm(H) 43cm(W) 25cm(D)	 Sun-BIO/WSA6/OAK Sun-BIO/WSA6/MAPLE Sun-BIO/WSA6/BEECH 40cm(H) 39cm(W) 26cm(D)
--	--	---	---

Designed and independently tested to conform to or exceed all the required standards and legislation. These cabinets provide secure storage with easy access to BODOSE medicine trays.



Code: Sun-BIO/MC15
BIODOSE medicine cabinet, 15 tray capacity



Code: Sun-BIO/MC30
BIODOSE medicine cabinet, 30 tray capacity

BIODOSE® Self Administration Medicine Cabinets

Designed specifically for the self-administration and storage of BODOSE medicine trays. These cabinets provide low level security, whilst being aesthetically pleasing and easy to clean.



Code: Sun-BIO/SA6
BIODOSE self administration mild steel medicine cabinet, 6 tray capacity



Code: Sun-BIO/WSA6/MAPLE
BIODOSE self administration medicine cabinet, 6 tray capacity - maple effect finish



Code: Sun-BIO/WSA6/OAK
BIODOSE self administration medicine cabinet, 6 tray capacity - oak effect finish



Code: Sun-BIO/WSA6/BEECH
BIODOSE self administration medicine cabinet, 6 tray capacity - beech finish



simple
hygienic
disposal

Bins & Sack Holders

Ergonomic and hygienic design, combined with strength and functionality is what makes our bins unique. Compliant to the latest Safe Management of Waste guidelines with fire retardancy, hands free operation and silent closing all as standard.



Bins

PAGE











127-128



Sack Holders

129-130

product information

 <p>3 sizes</p> <p>20, 50 & 70 litre capacity</p>	 <p>hands free</p> <p>Hygienic hands free operation, foot pedal must be used to open</p>	 <p>HTM07-01 compliant</p> <p>Safe management of healthcare waste compliant</p>	 <p>HTM05-03 tested</p> <p>Designed & tested to HTM05-03 Part A</p>	 <p>Silent, dampened closing lid as standard</p>
 <p>Corrosion resistant epoxy coated white galvanised bodies</p>	 <p>Silicone bag retaining cord with nylon finger loop</p>	 <p>Stainless steel foot pedal with pedal label (where applicable)</p>	 <p>Sealed base prevents leakages</p>	 <p>wall mounting bracket</p> <p>Integrated wall mounting bracket</p>
 <p>Off the wall design to help prevent damage</p>	 <p>Flame retardant **</p>	 <p>Easy clean design and materials</p>	 <p>2 year warranty</p>	 <p>Delivery normally within 3-5 working days *</p>



** Designed and tested to HTM05-03 Part A

* Please contact us regarding availability for quantities of 10 or more.

designated usage - please specify lid colour when ordering

 <p>General Use</p>	 <p>Waste for Incineration</p>	 <p>Domestic (Municipal) Waste</p>	 <p>Offensive/ Hygiene Waste</p>	 <p>Waste Which May Be Treated</p>
 <p>Cytotoxic & Cytostatic Waste</p>	 <p>Amalgam Waste</p>	 <p>Medical Waste for Incineration</p>	 <p>Anatomical Waste for Incineration</p>	

dimensions

 <p>20 Litre</p> <p>51cm(H) 32cm(W) 33cm(D)</p>	 <p>50 Litre</p> <p>59cm(H) 42cm(W) 43cm(D)</p>	 <p>70 Litre</p> <p>78cm(H) 42cm(W) 43cm(D)</p>
--	--	--

We are "The Strong Silent Type" and we don't like hands either! Designed for the multi function disposal of waste (HTM07-01), with usage designated by an appropriate coloured lid and pedal label.



Code: Sun-BIN20 - 20 Litre bin

Code: Sun-BIN50 - 50 Litre bin

Code: Sun-BIN70 - 70 Litre bin

product information - sack holders

<p>3 sizes</p> <p>20, 70 & 90 litre capacity</p>	 <p>Hygienic operation, foot pedal should be used to open</p>	 <p>Elasticated bag retaining cord with nylon finger loop</p>	 <p>Corrosion resistant materials</p>	<p>HTM07-01 compliant</p> <p>Safe management of healthcare waste compliant</p>
 <p>Easy clean design and materials</p>	 <p>1 year warranty</p>	 <p>Supplied fully assembled</p>	 <p>British made</p>	<p>express ITEM</p> <p>Delivery normally within 3-5 working days *</p>

* Please contact us regarding availability for quantities of 10 or more.

designated usage - please specify lid colour when ordering

 <p>General Use</p>	 <p>Waste for Incineration</p>	 <p>Domestic (Municipal) Waste</p>	 <p>Offensive/ Hygiene Waste</p>	 <p>Waste Which May Be Treated</p>
 <p>Cytotoxic & Cytostatic Waste</p>	 <p>Amalgam Waste</p>	 <p>Medical Waste for Incineration</p>	 <p>Anatomical Waste for Incineration</p>	

dimensions

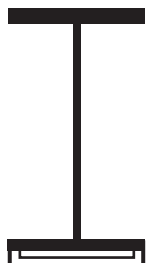
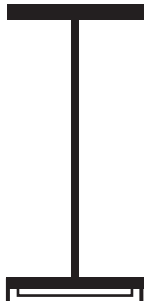
<p>20 Litre</p>  <p>58cm(H) 22cm(W) 35cm(D)</p>	<p>70 Litre</p>  <p>78cm(H) 43cm(W) 44cm(D)</p>	<p>90 Litre</p>  <p>86cm(H) 43cm(W) 44cm(D)</p>
---	---	---

Hands-free operation and sturdy design (HTM07-01) is what makes our sack holders hygienic and simple to use. They are ideal for areas where the risk of fire is minimal. Usage is designated by an appropriate coloured lid.



Code: Sun-BINSH20 - 20 Litre sack holder



Code: Sun-BINSH70 - 70 Litre sack holder



Code: Sun-BINSH90 - 90 Litre sack holder

hygienic
mobile
privacy

Mobile Screens

Smart design combined with ease of use is what makes our hygienic range of mobile screens unique. Choose from either our solid panel system or disposable one-piece curtain range, for ease of cleaning or to assist in reducing cross infection.

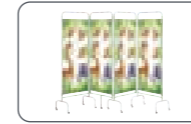

new

Mobile Screens - Solid Panels

PAGE

132-133



Mobile Screens - Disposable Curtains

134-135

product information

 Available in 3, 4 and 5 panel sizes	 Unique range of 8 patterns and colours	 Hygienic PVC panel system	 Panels can be removed or replaced	 Flame retardant panels - BS476 part 7
 Multiple leg supports for stability	 Swivel castors for ease of movement	 Durable epoxy coated white frame	 Folds flat for storage	 Easy clean design and materials
 Minimal assembly required	 2 year warranty	 British made		

dimensions

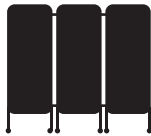
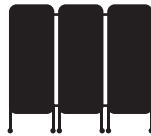
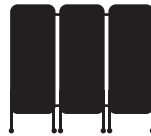
 3 Panel 172cm(H) 188cm(W) 3cm(D) 38cm(D) Across Legs	 4 Panel 172cm(H) 250cm(W) 3cm(D) 38cm(D) Across Legs	 5 Panel 172cm(H) 312cm(W) 3cm(D) 38cm(D) Across Legs
--	--	---

screen panel patterns and colours - please specify when ordering

 white	 beige	 silver	 sky blue	 blue patchwork	 bubble design	 wave design	 jungle design
--	--	---	---	---	--	---	--

Designed to provide a temporary or mobile privacy solution, our range of folding screens incorporate our unique hygienic panel system in 8 patterns and colours and are functional, durable and easy to clean.



Code: Sun-MFS3 - Three panel screen - Wave Design



Code: Sun-MFS4 - Four panel screen - Jungle Design



Code: Sun-MFS5 - Five panel screen - Bubble Design

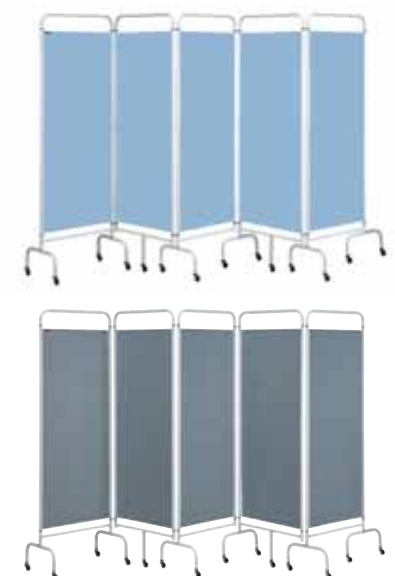

product information

3/4/5 sections	4 colours	££££ SAVING	unique	
Available in 3, 4 and 5 sections	Choice of 4 curtain colours	Cost effective disposable curtain system	Unique design	No laundry costs
Curtain labelling system for monitoring change dates	One piece pleated curtain - easy to fit or replace	Flame retardant curtains BS5867 part 2 type C	Infection control friendly	Recyclable polypropylene material
Multiple leg supports for stability	Durable epoxy coated white frame	Swivel castors for ease of movement	Folds flat for storage	Easy clean design and materials
minimal	2 Year Warranty	British Made		
Minimal assembly required	2 year warranty on frame	British made	Environmentally Friendly	Designed in partnership with Marlux Medical

accessories - replacement curtains

pastel blue	summer blue	forest green	beige
Sun-CUR3/DCPB - 3 Panel Sun-CUR4/DCPB - 4 Panel Sun-CUR5/DCPB - 5 Panel	Sun-CUR3/DCSB - 3 Panel Sun-CUR4/DCSB - 4 Panel Sun-CUR5/DCSB - 5 Panel	Sun-CUR3/DCFG - 3 Panel Sun-CUR4/DCFG - 4 Panel Sun-CUR5/DCFG - 5 Panel	Sun-CUR3/DCB - 3 Panel Sun-CUR4/DCB - 4 Panel Sun-CUR5/DCB - 5 Panel

dimensions

3 Panel 172cm(H) 188cm(W) 3cm(D) 38cm(D) Across Legs	4 Panel 172cm(H) 250cm(W) 3cm(D) 38cm(D) Across Legs	5 Panel 172cm(H) 312cm(W) 3cm(D) 38cm(D) Across Legs

curtain colours - please specify when ordering

pastel blue	summer blue	forest green	beige

Designed to provide a temporary or mobile privacy solution, and assist in reducing cross infection, our range of folding screens incorporate our unique disposable curtain system in 4 colours and are functional, durable and easy to clean.



Code: Sun-MFS3/DC
Three section screen with disposable curtain



Code: Sun-MFS4/DC
Four section screen with disposable curtain



Code: Sun-MFS5/DC
Five section screen with disposable curtain



individual
practical
solutions

Mirrors, Height Measure & Mobile Drip Stands

Practical solutions for general medical environments which are designed to assist both the patient and healthcare professional. Durable, functional and easy to clean and intended to provide a safer, more efficient and hygienic environment.



Medical Safety Mirrors

PAGE

137-138



Mobile Drip Stands



139-140

product information

 Durable shatter proof design	 5mm aircraft grade "plaskolite" acrylic	 Small (A5) to extra large	 Wall mounting tape supplied	 Smooth rounded corners
 Easy clean design and materials	 2 year warranty	 British made	 Delivery normally within 3-5 working days *	

* Please contact us regarding availability for quantities of 10 or more.

dimensions

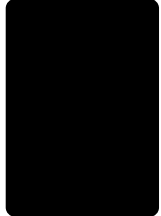
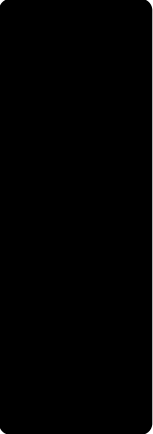
 Mirror 1 210mm(H) 148mm(W) 5mm(D) (A5 Size)	 Mirror 2 297mm(H) 210mm(W) 5mm(D) (A4 Size)	 Mirror 3 420mm(H) 297mm(W) 5mm(D) (A3 Size)	 Mirror 4 600mm(H) 350mm(W) 5mm(D)	 Mirror 5 1200mm(H) 350mm(W) 5mm(D)
---	---	---	--	--

Medical Safety Mirrors

Smart design and utilisation of modern materials is what makes our medical safety mirrors unique. Using shatter proof material as a modern alternative to glass makes them an ideal solution for medical rooms, public areas or high risk environments.

 Code: Sun-MIRROR1 (A5 Size)	 Code: Sun-MIRROR2 (A4 Size)	 Code: Sun-MIRROR3 (A3 Size)
--	--	--

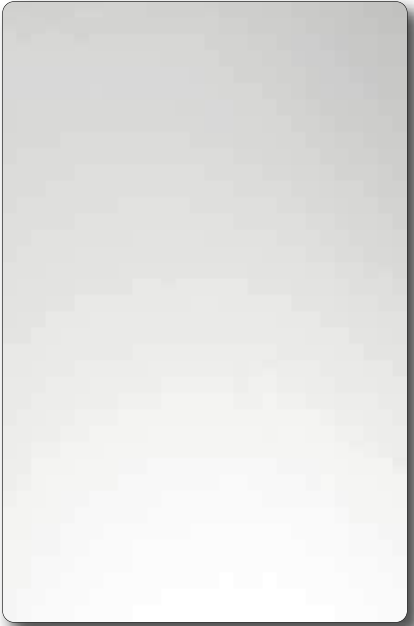
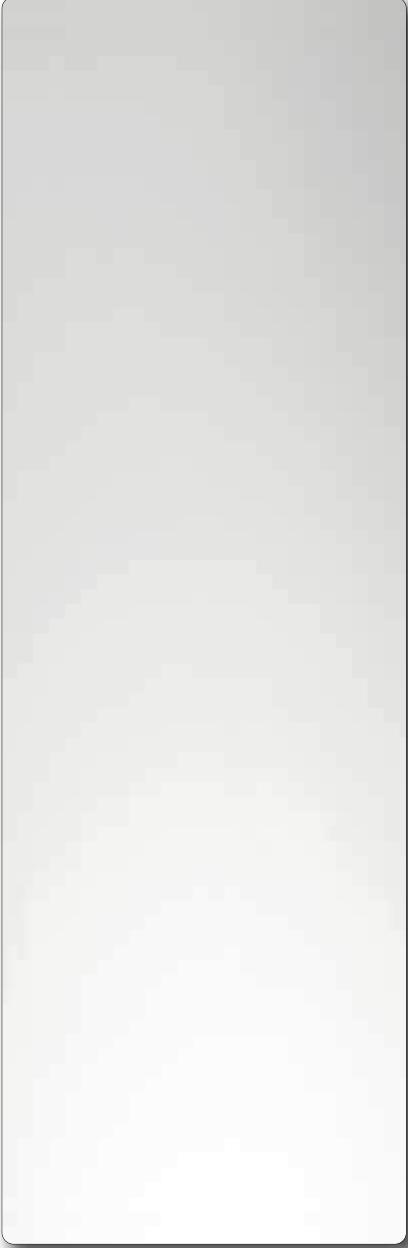



 Code: Sun-MIRROR4	 Code: Sun-MIRROR5
---	--

product information

HEIGHT RANGE 160-245cm Sun-IV01, IV02	HEIGHT RANGE 156-267cm Sun-IV08 & IV09	 Simple locking height adjustment	 Complies with BS3619:1976	 Chrome or stainless steel poles
 2kg hook load or 4kg total	 Lightweight design approx 3kg (Sun-IV01, IV02)	 Stable 5 star Plastic castor base (Sun-IV01 & IV02)	 5 Star Weighted base (Sun-IV08 & IV09)	 Antistatic castors (Sun-IV08, IV09)
 Simple self assembly required	 Easy clean design and materials	 2 year warranty	 British made	 Delivery normally within 3-5 working days *

* Please contact us regarding availability for quantities of 10 or more.

dimensions

			
Sun-IV01 160cm - 245cm(H) 51cm(W)	Sun-IV02 160cm - 245cm(H) 51cm(W)	Sun-IV08 156cm - 267cm(H) 58cm(W)	Sun-IV09 156cm - 267cm(H) 58cm(W)

Simple, practical, easy to adjust and manoeuvre, our drip stands are suitable for most healthcare environments. We can provide a lightweight design through to ones with heavy duty weighted bases, available in a choice of materials to suit your budget and hygiene requirements.



Code: **Sun-IV01**
Chrome steel drip stand, plastic base, 2 plastic hooks



Code: **Sun-IV02**
Chrome steel drip stand, plastic base, 4 chrome hooks



Code: **Sun-IV08**
Brushed stainless steel drip stand and weighted base, 2 chrome hooks, antistatic castors



Code: **Sun-IV09**
Brushed stainless steel drip stand and weighted base, 4 chrome hooks, antistatic castors

Furniture Packages

A choice of furniture packages to suit your budget, individual requirements and environment.



Furniture Packages

PAGE

142-143

individual
flexible
solutions

furniture package one

Colenso examination couch (navy upholstery*) with paper roll holder
 Single tier step (rectangular)
 3 panel mobile folding screen - white panels
 46cm wide dressing trolley with two glass effect safety trays
 Medium first aid cabinet with 2 shelves
 20 Litre bin - white



All additional room contents are for display purposes only

product information - furniture package two

Practitioner deluxe examination couch (navy upholstery*) with paper roll holder
 Single couch drawer unit in white
 Single tier step (rectangular)
 4 Panel mobile folding screen - silver panels
 46cm wide dressing trolley with three glass effect safety trays and drawer unit in white
 Medium first aid cabinet with 2 shelves
 20 Litre bin - white



All additional room contents are for display purposes only

product information - furniture package three

Practitioner deluxe examination couch (navy upholstery*) with paper roll holder
 Three couch drawer units in white
 Single tier step (oval)
 4 Panel mobile folding screen - silver panels
 Vista 30 trolley with 2 single and 2 double clear trays
 50cm Wide locking base cabinet - white
 50cm Wide locking wall cabinet - white
 20 Litre bin - white



All additional room contents are for display purposes only

product information - furniture package four

Specialist treatment couch (grey upholstery*) with paper roll holder and one drawerline unit & one drawer pack in white
 Double tier step (oval)
 4 Panel mobile folding screen - silver panels
 Vista 50 trolley with 4 single and 1 double clear tray
 100cm Wide locking base cabinet - white
 100cm Wide locking wall cabinet - white
 50 Litre bin - white



All additional room contents are for display purposes only

product information - furniture package five (school/restroom)

Alberti rest couch (sky blue upholstery*) with paper roll holder
 4 Panel mobile folding screen - bubble design panels
 VISTA 50 trolley with 6 single blue trays
 50cm Wide locking base cabinet & 50cm Wide locking wall cabinet - white
 20 Litre bin - white



All additional room contents are for display purposes only
 * Other upholstery colours available, please see inside back cover
 ** Please specify at time of ordering



Code: Sun-FP1
Furniture package one



Code: Sun-FP2
Furniture package two



Code: Sun-FP3
Furniture package three



Code: Sun-FP4
Furniture package four



Code: Sun-FP5
Furniture package five



FIRA Standard 6250 2005
 Specification:
 Adhesion Performance
 General/Severe



Anti-bacterial Vinyl Strength Test
 BS EN ISO 13934-1: 2013
 BS EN ISO 13973-3: 2000
 BS EN ISO 12947-2: 1998



Anti-bacterial Vinyl
 Fire (Flammability) Testing
 Flammability BS 7176 Medium Hazard
 BS 5852 : 2006 Clause 11
 (composites)



Sun-INST2**
 Assembly Service &
 Packaging Recycling

stylish
modular
storage

Cabinet Ranges

Aesthetically designed, contemporary range of cabinetry incorporating wall, base, corner and sink units all available in five finishes. Modular sizes, adjustable shelving and locks as standard.



Beech Cabinet Range

PAGE

145-146



White (High Gloss) Cabinet Range

147-148

product information



Quality, 18mm MFC carcass with 2mm edging



Locking doors supplied with 2 keys



Contemporary door and drawer profile



Stylish flush fitting handles



38mm deep dark grey laminate work top



Base cabinets have one adjustable shelf, wall cabinets have two



Easy clean design and materials



FIRA Standard 6250 2005 Specification: Adhesion Performance General/Severe

- Base cabinets can be combined and supplied with a one piece work top in lengths of up to 4.1m
- Cut to length worktop can be supplied upon request

accessories



Sun-DT1 Drawer Insert for 50cm Wide Drawers



Integrated Plumbing System (IPS) (see pages 150-151)



Sinks (HTM64) (see pages 152-155)



Taps (HTM64) (see pages 156-159)



Sinks & Taps (General) (see pages 160-161)

dimensions

All single door base & wall cabinets are supplied right handed (unless otherwise specified)

Sun-BU8B 30cm Base Cabinet

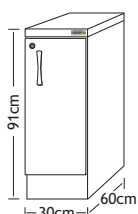

Sun-BU1B 50cm Base Cabinet

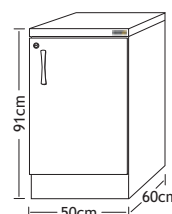

Sun-BU2B 50cm Drawerline Cabinet

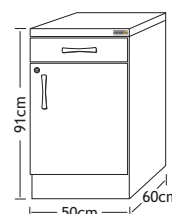

Sun-BU3B 50cm 5 Drawer Pack

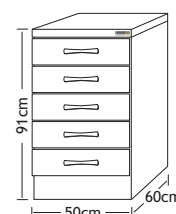

Sun-BU4B 100cm Base Cabinet

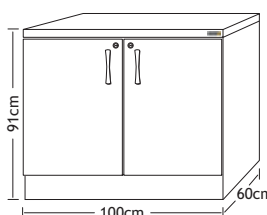

Sun-BU5B 100cm Drawerline Cabinet

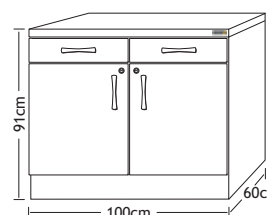

Sun-BU6B 100cm Sink Cabinet (excludes sink)

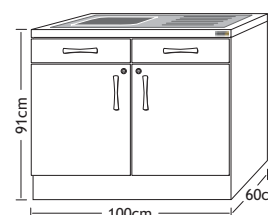

Sun-BU7B L-Shaped Corner Base Cabinet

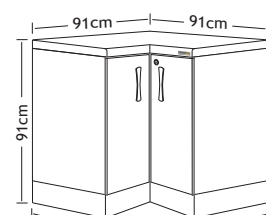

Also available in 40cm, 60cm and 80cm widths

Sun-WU1B 30cm Wall Cabinet

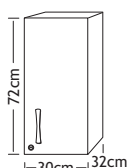

Sun-WU2B 50cm Wall Cabinet

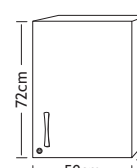

Sun-WU3B 100cm Wall Cabinet

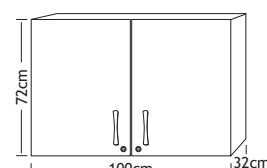

Sun-WU4B Corner Wall Cabinet

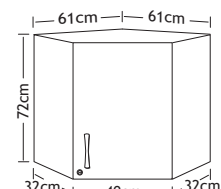

Also available in 40cm, 60cm and 80cm widths

Aesthetically designed, contemporary range of modular cabinetry incorporating wall, base, corner and sink units finished in beech effect. Easy to clean, adjustable shelves and locks as standard.



2 year warranty



Supplied fully assembled



product information



Quality, 18mm MFC carcass with 2mm edging



Locking doors supplied with 2 keys



Contemporary door and drawer profile



Stylish flush fitting handles



38mm deep crystal white laminate work top



Base cabinets have one adjustable shelf, wall cabinets have two



Easy clean design and materials



FIRA Standard 6250 2005 Specification: Adhesion Performance General/Severe

- Base cabinets can be combined and supplied with a one piece work top in lengths of up to 4.1m
- Cut to length worktop can be supplied upon request

accessories



Sun-DT1
Drawer Insert for 50cm Wide Drawers



Integrated Plumbing System (IPS)
(see pages 150-151)



Sinks (HTM64)
(see pages 152-155)



Taps (HTM64)
(see pages 156-159)



Sinks & Taps (General)
(see pages 160-161)

dimensions

All single door base & wall cabinets are supplied right handed (unless otherwise specified)

Sun-BU8W 30cm Base Cabinet

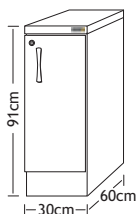

Sun-BU1W 50cm Base Cabinet

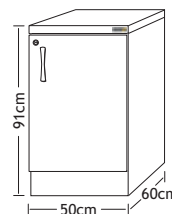

Sun-BU2W 50cm Drawerline Cabinet

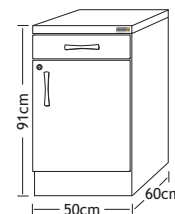

Sun-BU3W 50cm 5 Drawer Pack

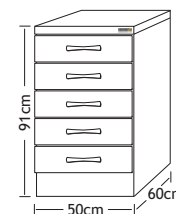

Sun-BU4W 100cm Base Cabinet

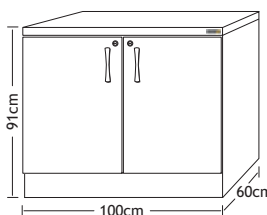

Sun-BU5W 100cm Drawerline Cabinet

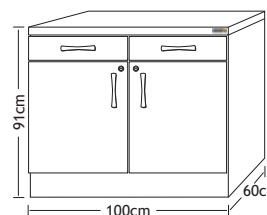

Sun-BU6W 100cm Sink Cabinet (excludes sink)

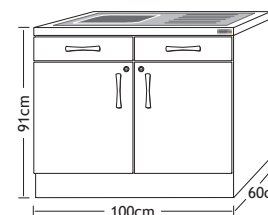

Sun-BU7W L-Shaped Corner Base Cabinet

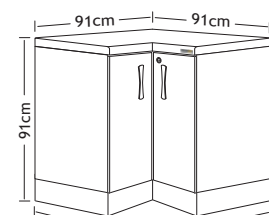

Also available in 40cm, 60cm and 80cm widths

Sun-WU1W 30cm Wall Cabinet

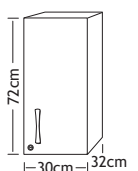

Sun-WU2W 50cm Wall Cabinet

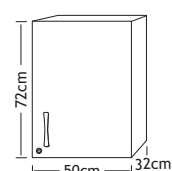

Sun-WU3W 100cm Wall Cabinet

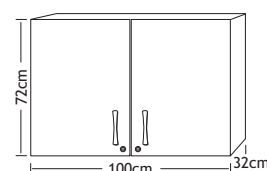

Sun-WU4W Corner Wall Cabinet

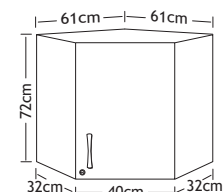

Also available in 40cm, 60cm and 80cm widths

Aesthetically designed, contemporary range of modular cabinetry incorporating wall, base, corner and sink units finished in high gloss white. Easy to clean, adjustable shelves and locks as standard.



2 year warranty



Supplied fully assembled



efficient
clinical
cleansing

Integrated Plumbing Systems, Sinks & Taps

Designed to assist in helping reduce cross infection and improve general hygiene, we can provide a range of HTM64 compliant clinical solutions from Integrated Plumbing Systems (IPS), sinks and taps for clean and dirty areas, as well as general hand washing applications.

	PAGE
 Integrated Plumbing Systems	150-151
 Sinks (HTM64 Compliant)	152-155
 Taps (HTM64 Compliant)	156-159
 Sinks & Taps (General Healthcare)	160-161

product information

<p>HTM64 compliant</p> <p>For use in clinical areas</p>	 <p>Hygienic and durable design</p>	 <p>Removable postformed panels</p>	<p>18mm LFMDF</p> <p>Laminate faced MDF panels</p>	 <p>Optional sloping top for extra high ceilings</p>
<p>4 Widths 3 Heights</p> <p>4 standard widths in 3 different heights</p>	 <p>Easy clean design and materials</p>	 <p>FIRA Standard 6250 2005 Specification: Adhesion Performance General/Severe</p>	<p>installation</p>  <p>Professional installation available</p>	

accessories * Required for sink installation and for HTM64 compliance

 <p>Sun-SNK14 Washbasin - medium (see pages 154-155)</p>	 <p>FIXING kit Sun-SNK14/KIT* Panel fixing kit for Sun-SNK14</p>	 <p>SINK adapter Sun-SNK14/KIT1* Sink outlet adapter for Sun-SNK14</p>	 <p>Sun-DISPENSER9 GOJO touch free dispenser for foaming soap</p>	 <p>Sun-DISPENSER11 Purell touch free dispenser for hand rub gel</p>
 <p>Sun-SNK15 Washbasin - large (see pages 154-155)</p>	 <p>FIXING kit Sun-SNK15/KIT* Panel fixing kit for Sun-SNK15</p>	 <p>SINK adapter Sun-SNK15/KIT1* Sink outlet adapter for Sun-SNK15</p>	 <p>Sun-DISPENSER4 Paper towel dispenser</p>	 <p>Medical Safety Mirrors (see pages 137-138)</p>
 <p>Sun-TAP15 Electronic thermostatic mixer tap with time flow sensor</p>	 <p>Sun-TAP16 Electronic thermostatic mixer tap with proximity sensor</p>	 <p>Sun-TAP17 Thermostatic sequential mixer tap</p>		

dimensions & codes

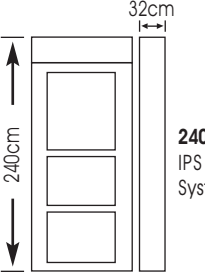
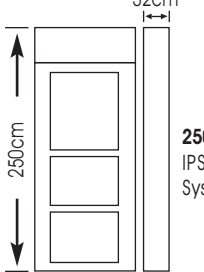
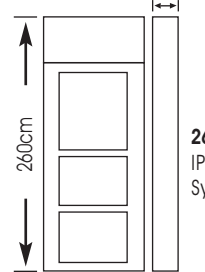
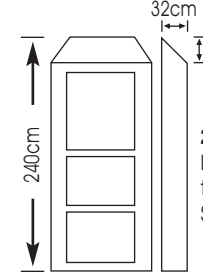
 <p>240cm(H) IPS Panel System</p>	 <p>250cm(H) IPS Panel System</p>	 <p>260cm(H) IPS Panel System</p>	 <p>240cm(H) IPS Sloping top Panel System</p>
<p>Sun-IPS1/LFMDF/240/70/WHITE 240cm(H) 70cm(W) 32cm(D)</p> <p>Sun-IPS2/LFMDF/240/80/WHITE 240cm(H) 80cm(W) 32cm(D)</p> <p>Sun-IPS3/LFMDF/240/90/WHITE 240cm(H) 90cm(W) 32cm(D)</p> <p>Sun-IPS4/LFMDF/240/100/WHITE 240cm(H) 100cm(W) 32cm(D)</p>	<p>Sun-IPS1/LFMDF/250/70/WHITE 250cm(H) 70cm(W) 32cm(D)</p> <p>Sun-IPS2/LFMDF/250/80/WHITE 250cm(H) 80cm(W) 32cm(D)</p> <p>Sun-IPS3/LFMDF/250/90/WHITE 250cm(H) 90cm(W) 32cm(D)</p> <p>Sun-IPS4/LFMDF/250/100/WHITE 250cm(H) 100cm(W) 32cm(D)</p>	<p>Sun-IPS1/LFMDF/260/70/WHITE 260cm(H) 70cm(W) 32cm(D)</p> <p>Sun-IPS2/LFMDF/260/80/WHITE 260cm(H) 80cm(W) 32cm(D)</p> <p>Sun-IPS3/LFMDF/260/90/WHITE 260cm(H) 90cm(W) 32cm(D)</p> <p>Sun-IPS4/LFMDF/260/100/WHITE 260cm(H) 100cm(W) 32cm(D)</p>	<p>Sun-IPS8/LFMDF/240/70/WHITE 240cm(H) 70cm(W) 32cm(D)</p> <p>Sun-IPS8/LFMDF/240/80/WHITE 240cm(H) 80cm(W) 32cm(D)</p> <p>Sun-IPS8/LFMDF/240/90/WHITE 240cm(H) 90cm(W) 32cm(D)</p> <p>Sun-IPS8/LFMDF/240/100/WHITE 240cm(H) 100cm(W) 32cm(D)</p>

Our range of HTM64 compliant integrated plumbing systems (IPS), combine a range of healthcare sanitary ware fitted into a specially designed pre-assembled panel arrangement. They are suitable for use in both clinical and personal washing areas and provide a cost-effective, functional and easy to maintain solution.



2 year warranty on panels



Sinks (HTM64 Compliant)

product information - Sun-SNK24 & 25

 For use in clinical areas	 No plug, chain or overflow	 Available in left or right hand drainer	 Premium quality stainless steel	 200mm tap centres
 Fixing kit supplied	 Bottle trap and waste kit needed (see accessories)*	 Easy clean design and materials	 1 year warranty	 British made

* Required for sink installation and for HTM64 compliance

product information - Sun-SNK28

 For use in clinical areas	 Premium quality stainless steel	 No plug, chain or overflow	 Fixing kit supplied	 Bottle trap & waste kit needed (see accessories)*
 Easy clean design and materials	 1 year warranty	 British made		

* Required for sink installation and for HTM64 compliance

accessories - (please see pages 167-172 for our full range & specification of taps)

 Sun-SNK24 & 25/WK* Waste kit	 Sun-SNK24 & 25/BT* Bottle trap	 Sun-SNK28/WK* Waste kit	 Sun-SNK28/BT* Bottle trap	 Sun-TAP13 Deck mounted sequential thermostatic mixer tap
--	--	---	---	---

* Required for sink installation and for HTM64 compliance

dimensions

Sun-SNK24 & Sun-SNK25

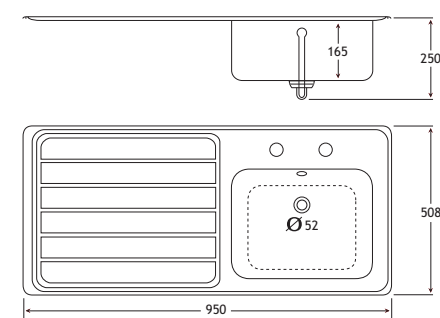

Sun-SNK28

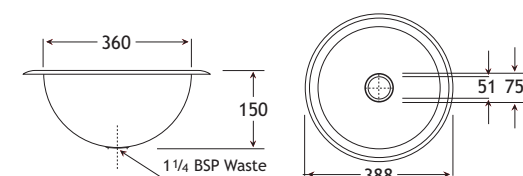

Sinks (HTM64 Compliant)

Our range of HTM64 compliant inset stainless steel sinks and bowls are suitable for clean and dirty areas as well as clinical healthcare applications.

Inset Sinks

HTM64 compliant inset stainless steel sink, available with left or right hand drainer.



Code: Sun-SNK24 - Inset stainless steel sink with right hand drainer



Code: Sun-SNK25 - Inset stainless steel sink with left hand drainer



Code: Sun-SNK28 - Inset stainless steel hemispherical bowl

Sinks (HTM64 Compliant)





product information - Sun-SNK14 & 15





 HTM64 compliant For use in clinical areas	 No plug, chain or overflow	 Suitable for IPS systems	 Back Outlet Adapter Back outlet adapter needed (see accessories)*	 1 year warranty
---	---	---	--	--

product information - Sun-SNK16, 17 & 18

 HTM64 compliant Suitable for personal washing only	 No plug, chain or overflow	 Single tap hole (right hand side)	 Bottle Trap & Waste Kit Bottle trap & waste kit needed (see accessories)*	 1 year warranty
--	---	--	--	--

accessories

 Panel Fixing Kit Sun-SNK14/KIT* (for Sun-SNK14) Sun-SNK15/KIT* (for Sun-SNK15)	 Back Outlet Adapter Sun-SNK14/KIT1* (for Sun-SNK14) Sun-SNK15/KIT1* (for Sun-SNK15)	 Wall Fixing Kit Sun-SNK16/KIT1* (for Sun-SNK16) Sun-SNK17/KIT1* (for Sun-SNK17) Sun-SNK18/KIT1* (for Sun-SNK18)	 Panel Fixing Kit Sun-SNK16/KIT2* (for Sun-SNK16) Sun-SNK17/KIT2* (for Sun-SNK17) Sun-SNK18/KIT2* (for Sun-SNK18)	 Waste Kit Sun-SNK16/WK* (for Sun-SNK16) Sun-SNK17/WK* (for Sun-SNK17) Sun-SNK18/WK* (for Sun-SNK18)
---	--	---	--	---

 Bottle Trap Sun-SNK16/BT* (for Sun-SNK16) Sun-SNK17/BT* (for Sun-SNK17) Sun-SNK18/BT* (for Sun-SNK18)	 Sun-TAP15 Electronic thermostatic mixer tap with time flow sensor (for Sun-SNK14 & 15)	 Sun-TAP16 Electronic thermostatic mixer tap with proximity sensor (for Sun-SNK14 & 15)	 Sun-TAP17 Thermostatic sequential mixer tap (for Sun-SNK14 & 15)	 Sun-TAP18 Washbasin mixer tap (for Sun-SNK16, 17 & 18)
--	---	---	---	---

* Required for sink installation and for HTM64 compliance

dimensions

Sun-SNK14 & Sun-SNK15

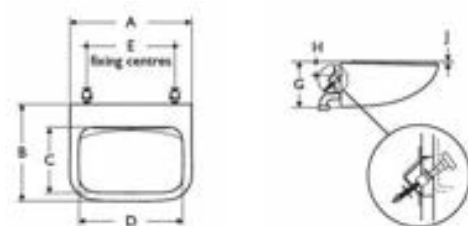

	A	B	C	D	E	G	H	J
Sun-SNK14 (M)	500	400	270	425	360	187	53	7
Sun-SNK15 (L)	600	480	342	500	450	196	55	9

Sun-SNK16, Sun-SNK17 & Sun-SNK18

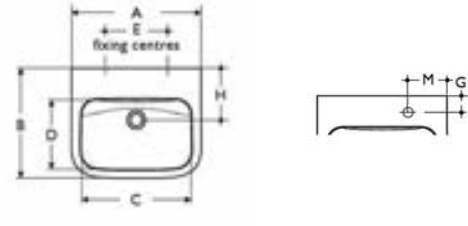

	A	B	C	D	E	G	H	M
Sun-SNK16 (S)	400	365	333	216	190-210	62	190	150
Sun-SNK17 (M)	500	420	420	265	215-265	62	195	150
Sun-SNK18 (L)	600	479	503	315	270-290	63	195	200

Sinks (HTM64 Compliant)

Washbasins

Our range of HTM64 compliant washbasins are suitable for use in clinical areas and for duct panels on integrated plumbing systems (IPS). Made from vitreous china to BS 3402.



Code: **Sun-SNK14**
Washbasin (rear draining) - medium



Code: **Sun-SNK15**
Washbasin (rear draining) - large



Our range of HTM64 compliant washbasins are suitable for personal washing (face, forearms and hands). Made from vitreous china to BS 3402.



Code: **Sun-SNK16**
Washbasin (bottom draining) - small



Code: **Sun-SNK17**
Washbasin (bottom draining) - medium



Code: **Sun-SNK18**
Washbasin (bottom draining) - large

product information - Sun-TAP13

 Suitable for clinical use	 200mm tap centres	 Integrated thermostat regulates temperature	 180° Span single lever operation	 Built in thermostat cleansing feature (requires bridging hose)
 Durable attractive chrome finish	 Easy clean design and materials	 1 year warranty	 British made	

product information - Sun-TAP15

 Suitable for clinical use	 Pre-determined water running length time (set up on installation)	 Suitable for scrub up applications	 200mm tap centres	 Integral thermostat
 Built in thermostat cleansing feature (requires bridging hose)	 Durable attractive chrome finish	 Easy clean design and materials	 1 year warranty	 British made

product information - Sun-TAP16

 Suitable for clinical use	 For use in general areas where water saving benefits are required	 Activates and stops by movement and proximity	 200mm tap centres	 Integral thermostat
 Built in thermostat cleansing feature (requires bridging hose)	 Durable attractive chrome finish	 Easy clean design and materials	 1 year warranty	 British made

Our range of HTM64 compliant taps are suitable for use in clinical areas and in duct panels on integrated plumbing systems (IPS).

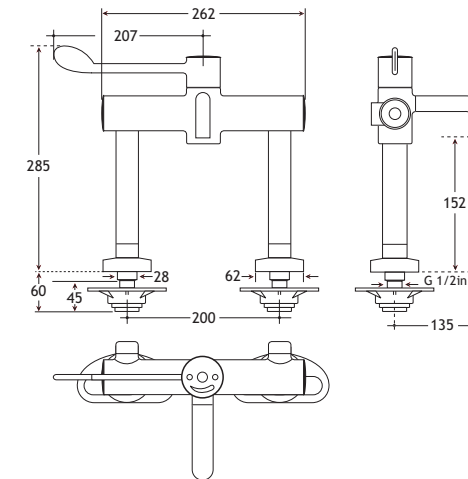

Code: Sun-TAP13
Deck mounted sequential thermostatic mixer tap

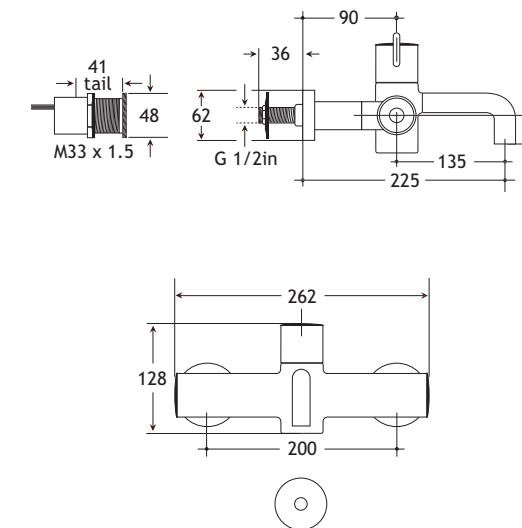

Code: Sun-TAP15
Electronic thermostatic mixer tap with time flow sensor

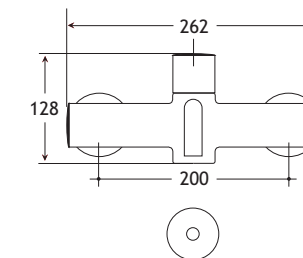

Code: Sun-TAP16
Electronic thermostatic mixer tap with proximity sensor

Taps (HTM64 Compliant)

product information - Sun-TAP17

 <p>HTM64 compliant</p>	 <p>For use in general areas</p>	 <p>200mm tap centres</p>	 <p>Integral thermostat</p>	 <p>180°</p>
<p>Suitable for clinical use</p>	<p>For use in general areas</p>	<p>200mm tap centres</p>	<p>Integral thermostat</p>	<p>180° Span single lever operation</p>
 <p>Built in thermostat cleansing feature (requires bridging hose)</p>	 <p>Durable attractive chrome finish</p>	 <p>Easy clean design and materials</p>	 <p>1 year warranty</p>	 <p>British made</p>

product information - Sun-TAP18

 <p>HTM64 compliant</p>	 <p>Sequential operation means water starts at cold, removing risk of scalding</p>	 <p>Integral thermostat</p>	 <p>Single lever operation providing ease of use for the less able</p>	 <p>Suitable for use with Sun-SNK17 & 18 washbasins</p>
<p>Suitable for personal washing only</p>	<p>Sequential operation means water starts at cold, removing risk of scalding</p>	<p>Integral thermostat</p>	<p>Single lever operation providing ease of use for the less able</p>	<p>Suitable for use with Sun-SNK17 & 18 washbasins</p>
 <p>Durable attractive chrome finish</p>	 <p>Easy clean design and materials</p>	 <p>1 year warranty</p>	 <p>British made</p>	

Taps (HTM64 Compliant)

Our range of HTM64 compliant taps are suitable for use in clinical areas and personal cleansing.

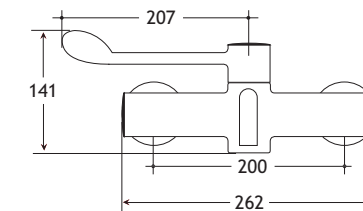
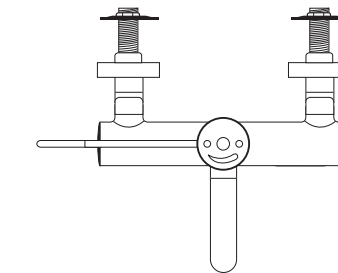
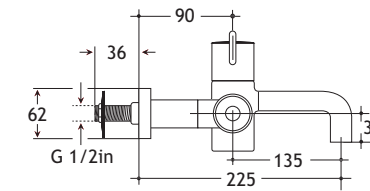



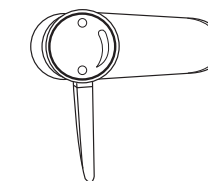
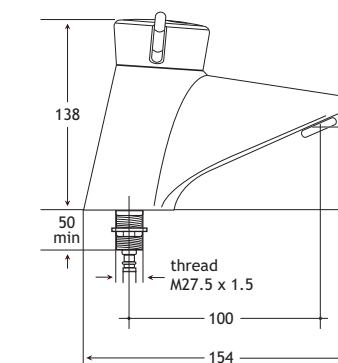





Code: **Sun-TAP17**
Thermostatic sequential mixer tap



Code: **Sun-TAP18**
Washbasin mixer tap

product information - Sun-SNK30

 <p>General healthcare</p>	 <p>200mm tap centres</p>	 <p>Premium quality vitreous china</p>	 <p>Counter/worktop inset design</p>	 <p>No plug, chain or overflow</p>
 <p>Easy clean design and materials</p>	 <p>1 year warranty</p>	 <p>British made</p>		

Suitable for general healthcare and personal washing, our range of sinks and taps are designed to improve hygiene in healthcare environments.

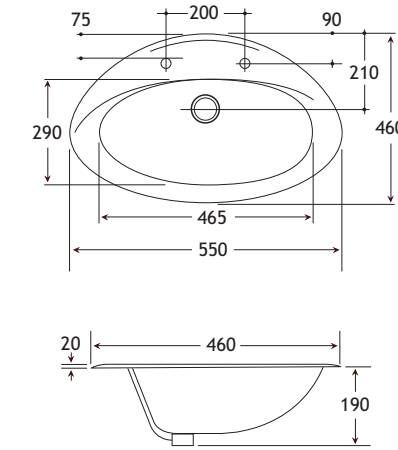

Code: **Sun-SNK30**
Vitreous china inset washbasin

product information - Sun-TAP5

 <p>General healthcare</p>	 <p>200mm projection swivel spout</p>	 <p>200mm tap centres</p>	 <p>Durable attractive chrome finish</p>	 <p>Traditional twin lever "elbow operation" design</p>
 <p>Easy clean design and materials</p>	 <p>1 year warranty</p>	 <p>British made</p>		

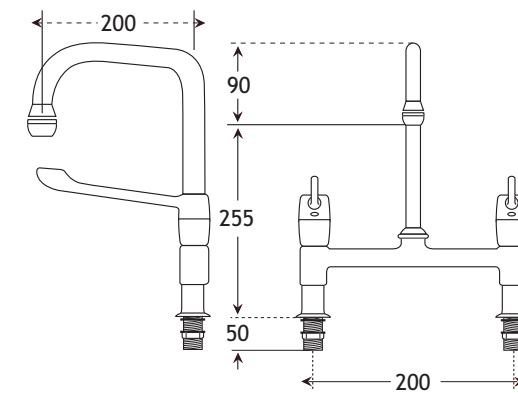

Code: **Sun-TAP5**
Traditional twin lever mixer tap















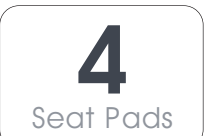

relaxing
contemporary
support

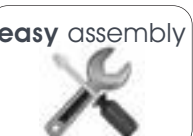
Visitor, Patient & Waiting Room Seating

Contemporary, durable and hygienic range of visitor and patient seating designed for healthcare environments. Available in a wide range of colours, patterns and fabrics, including anti-bacterial.

		PAGE
	new Neptune Visitor 3 Seat Modular Seating	163-164
	new Neptune Visitor 4 Seat Modular Seating	165-166
	new Neptune Visitor 5 Seat Modular Seating	167-168
	new Neptune Visitor Chairs	169-170
	Venus Visitor 3 Seat Modular Seating	171-172
	Venus Visitor 4 Seat Modular Seating	173-174
	Venus Visitor 5 Seat Modular Seating	175-176
	Visitor & Patient Chairs	177-182
	Atlas Seating	183-186
	Bariatric Chairs	187-190

product information

 Maximum user weight (20st.) per seat	 One piece durable moulded polypropylene seats	 Comfortable foam upholstered seat pads	 Strong ergonomic chrome arms	 Stable ergonomic chrome legs
 Adjustable feet for uneven floors	 Available in 7 moulded seat colours	 Choice of 4 upholstered seat pads	 Vinyl or inter/vene Anti-bacterial upholstery	 Minimal assembly required (tools supplied)
 Optional installation service available	 5 year upholstery wearability warranty (inter/vene only)	 2 year warranty on vinyl, frame and moulded seats	 Easy clean design and materials	 Anti-bacterial Vinyl Strength Test BS EN ISO 13934-1: 2013 BS EN ISO 13973-3: 2000 BS EN ISO 12947-2: 1998
 Anti-bacterial Vinyl	 British made			

Fire (Flammability) Testing
Flammability BS 7176 Medium Hazard
BS 5852 : 2006 Clause 11 (composites)

dimensions

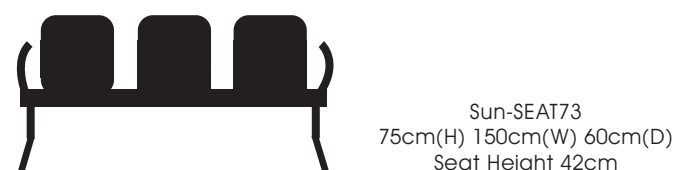

moulded seat and upholstery colours - please specify when ordering
please see inside back cover for full specification of our upholstery range

moulded seat colours

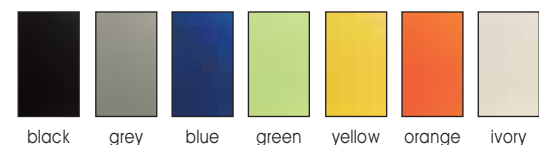

anti-bacterial vinyl
seat pad upholstery colours

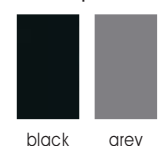

anti-bacterial inter/vene™
seat pad upholstery colours



new



Code: **Sun-SEAT73/3/BLACK** - Neptune visitor 3 seat module in black - 2 chrome arms



Code: **Sun-SEAT73/3/GREEN/VYL/BLK**
Neptune visitor 3 seat module in green with 3 black seat pads in anti-bacterial vinyl - 2 chrome arms



Code: **Sun-SEAT73/3/YELLOW/IV/GRY**
Neptune visitor 3 seat module in yellow with 3 grey seat pads in anti-bacterial inter/vene - 2 chrome arms

product information

 127kg Maximum user weight (20st.) per seat	 One piece durable moulded polypropylene seats	 Comfortable foam upholstered seat pads	 Strong ergonomic chrome arms	 Stable ergonomic chrome legs
 Adjustable feet for uneven floors	 7 Seat Colours Available in 7 moulded seat colours	 4 Seat Pads Choice of 4 upholstered seat pads	 Vinyl or inter/vene Anti-bacterial upholstery	 easy assembly Minimal assembly required (tools supplied)
 Optional installation service available	 5 Year Upholstery Warranty 5 year upholstery wearability warranty (inter/vene only)	 2 Year Warranty 2 year warranty on vinyl, frame and moulded seats	 eze Easy clean design and materials	 FIRA Independently tested by FIRA Anti-bacterial Vinyl Strength Test BS EN ISO 13934-1: 2013 BS EN ISO 13973-3: 2000 BS EN ISO 12947-2: 1998
 Anti-bacterial Vinyl Fire (Flammability) Testing Flammability BS 7176 Medium Hazard BS 5852 : 2006 Clause 11 (composites)	 British made			

dimensions



moulded seat and upholstery colours - please specify when ordering
please see inside back cover for full specification of our upholstery range

moulded seat colours

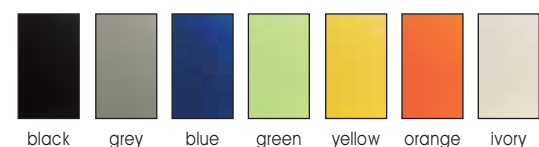

anti-bacterial vinyl seat pad upholstery colours

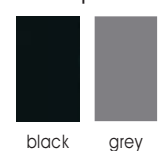

anti-bacterial inter/vene™ seat pad upholstery colours



Neptune offers a contemporary range of seating modules and chairs, with great design and stability whilst being durable, hygienic and easy to clean. Available in 7 modern and vibrant colours with the option of upholstered seat pads in 2 anti-bacterial materials, vinyl and inter/vene™.



Code: Sun-SEAT74/4/ORANGE - Neptune visitor 4 seat module in orange - 2 chrome arms













Code: Sun-SEAT74/4/IVORY/VYL/GRY
Neptune visitor 4 seat module in ivory with 4 grey seat pads in anti-bacterial vinyl - 2 chrome arms

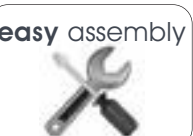

Code: Sun-SEAT74/4/BLUE/IV/BLK
Neptune visitor 4 seat module in blue with 4 black seat pads in anti-bacterial inter/vene - 2 chrome arms

product information

 Maximum user weight (20st.) per seat	 One piece durable moulded polypropylene seats	 Comfortable foam upholstered seat pads	 Strong ergonomic chrome arms	 Stable ergonomic chrome legs
 Adjustable feet for uneven floors	7 Seat Colours Available in 7 moulded seat colours	4 Seat Pads Choice of 4 upholstered seat pads	 Vinyl or inter/vene Anti-bacterial upholstery	easy assembly  Minimal assembly required (tools supplied)
installation  Optional installation service available	5 5 Year Upholstery Warranty 5 year upholstery wearability warranty (inter/vene only)	2 2 Year Warranty 2 year warranty on vinyl, frame and moulded seats	 Easy clean design and materials	FIRA Independently tested by FIRA Anti-bacterial Vinyl Strength Test BS EN ISO 13934-1: 2013 BS EN ISO 13973-3: 2000 BS EN ISO 12947-2: 1998
 Anti-bacterial Vinyl Fire (Flammability) Testing Flammability BS 7176 Medium Hazard BS 5852 : 2006 Clause 11 (composites)	 British made			

dimensions



Sun-SEAT75
75cm(H) 250cm(W) 60cm(D)
Seat Height 42cm

moulded seat and upholstery colours - please specify when ordering
please see inside back cover for full specification of our upholstery range

moulded seat colours

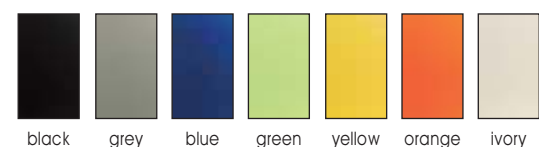

anti-bacterial vinyl seat pad upholstery colours

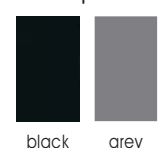

anti-bacterial inter/vene™ seat pad upholstery colours



Neptune offers a contemporary range of seating modules and chairs, with great design and stability whilst being durable, hygienic and easy to clean. Available in 7 modern and vibrant colours with the option of upholstered seat pads in 2 anti-bacterial materials, vinyl and inter/vene™.

new



Code: **Sun-SEAT75/5/YELLOW** - Neptune visitor 5 seat module in yellow - 2 chrome arms

















Code: **Sun-SEAT75/5/GREY/VYL/BLK**
Neptune visitor 5 seat module in grey with 5 black seat pads in anti-bacterial vinyl - 2 chrome arms



Code: **Sun-SEAT75/5/ORANGE/IV/GRY**
Neptune visitor 5 seat module in orange with 5 grey seat pads in anti-bacterial inter/vene - 2 chrome arms

product information

 127kg Maximum user weight (20st.) per seat	 One piece durable moulded polypropylene seat	 Comfortable foam upholstered seat pad	 Comfortable and durable moulded arm rests (Sun-SEAT71 only)	 Optional chair linking kit
 7 Seat Colours Available in 7 moulded seat colours	 4 Seat Pads Choice of 4 upholstered seat pads	 Anti-bacterial vinyl and inter/vene upholstery	 Supplied fully assembled	 5 year upholstery wearability warranty (inter/vene only)
 2 Year Warranty 2 year warranty on vinyl, frame and moulded seats	 Easy clean design and materials	 Anti-bacterial Vinyl Strength Test BS EN ISO 13934-1: 2013 BS EN ISO 13973-3: 2000 BS EN ISO 12947-2: 1998	 Fire (Flammability) Testing Flammability BS 7176 Medium Hazard BS 5852 : 2006 Clause 11 (composites)	 British made

Neptune offers a contemporary range of chairs and seating modules, with great design and stability whilst being durable, hygienic and easy to clean. Available in 7 modern and vibrant colours with the option of upholstered seat pads in 2 anti-bacterial materials, vinyl and inter/vene™.



Code: **Sun-SEAT70/ORANGE/VYL/BLK**
Neptune visitor chair in orange with black vinyl upholstered seat pad



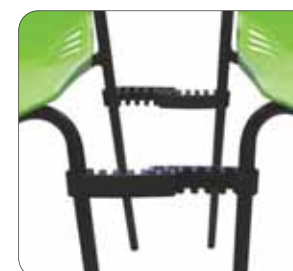

Code: **Sun-SEAT71/GREEN/VYL/GRY**
Neptune visitor chair with arms in green and grey vinyl upholstered seat pad



Code: **Sun-SEAT7071/LINK**
Neptune Visitor Chair Linking Kit (2 sets per chair for front & back legs)

dimensions

Sun-SEAT70  78cm(H) 47cm(W) 47cm(D) Seat Height 47cm	Sun-SEAT71  78cm(H) 61cm(W) 47cm(D) Seat Height 47cm
---	---

accessories



Sun-SEAT7071/LINK
Neptune Visitor Chair Linking Kit (2 sets per chair for front & back legs)

moulded seat and upholstery colours - please specify when ordering
please see inside back cover for full specification of our upholstery range

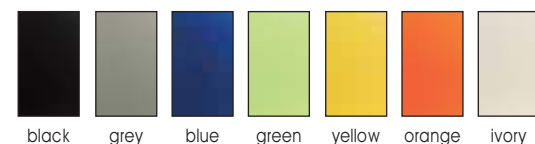
moulded seat colours

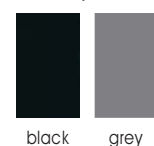

anti-bacterial vinyl seat pad upholstery colours



anti-bacterial inter/vene™ seat pad upholstery colours



Code: **Sun-SEAT71/BLUE/IV/GRY**
Neptune visitor chair with arms in blue and grey inter/vene upholstered seat pad





Code: **Sun-SEAT70/YELLOW/IV/BLK**
Neptune visitor chair in yellow with black inter/vene upholstered seat pad



product information

 Maximum user weight (17st.) per seat	 Durable moulded polypropylene seats	 Comfortable deep foam upholstered seats	 Rounded/upholstered seat corners	 Vinyl or inter/vene Anti-bacterial upholstery
 Adjustable feet for uneven floors	 Durable silver epoxy coated frame	 Magazine table option	 Minimal assembly required (tools supplied)	 Optional installation service available
 5 year upholstery wearability warranty (inter/vene only)	 2 year warranty on frame and moulded seats	 Easy clean design and materials	 Anti-bacterial Vinyl Strength Test BS EN ISO 13934-1: 2013 BS EN ISO 13973-3: 2000 BS EN ISO 12947-2: 1998	 Fire (Flammability) Testing Flammability BS 7176 Medium Hazard BS 5852 : 2006 Clause 11 (composites)
 British made				

dimensions

 Sun-SEAT3 78cm(H) 153cm(W) 66cm(D)	 Sun-SEAT3T 78cm(H) 153cm(W) 66cm(D)	 Magazine Table 45cm(W) 45cm(D)
--	---	--







upholstery colours - please specify when ordering

please see inside back cover for full specification of our upholstery range

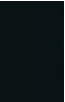





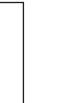



polypropylene seats

			
black	blue	grey	beige

anti-bacterial vinyl upholstery colours

														
black	grey	beige	primrose	walnut	red wine	salmon	lavender	navy	mid blue	sky blue	cool blue	green	mint	white

anti-bacterial inter/vene™ upholstery colours

									
black	grey	beige	yellow	plum	red	navy	sky blue	green	pastel green

Contemporary range of 3 seat seating modules, which are durable, hygienic and easy to clean. Available in a wide range of colours and anti-bacterial fabrics.



Code: **Sun-SEAT3** - Venus visitor 3 seat module with moulded polypropylene seats
Code: **Sun-SEAT3T** - Venus visitor 2 seat & 1 table module with moulded polypropylene seats



Code: **Sun-SEAT3VYL** - Venus visitor 3 seat module with anti-bacterial vinyl upholstery
Code: **Sun-SEAT3TVYL** - Venus visitor 2 seat & 1 table module with anti-bacterial vinyl upholstery





Code: **Sun-SEAT3IV** - Venus visitor 3 seat module with anti-bacterial inter/vene upholstery
Code: **Sun-SEAT3TIV** - Venus visitor 2 seat & 1 table module with anti-bacterial inter/vene upholstery

product information

 Maximum user weight (17st.) per seat	 Durable moulded polypropylene seats	 Comfortable deep foam upholstered seats	 Rounded/upholstered seat corners	 Vinyl or inter/vene Anti-bacterial upholstery
 Adjustable feet for uneven floors	 Durable silver epoxy coated frame	 Magazine table option	 Minimal assembly required (tools supplied)	 Optional installation service available
 5 year upholstery wearability warranty (inter/vene only)	 2 year warranty on frame and moulded seats	 Easy clean design and materials	 Anti-bacterial Vinyl Strength Test BS EN ISO 13934-1: 2013 BS EN ISO 13973-3: 2000 BS EN ISO 12947-2: 1998	 Anti-bacterial Vinyl Fire (Flammability) Testing Flammability BS 7176 Medium Hazard BS 5852 : 2006 Clause 11 (composites)
 British made				

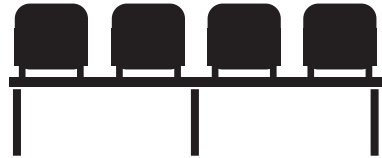
dimensions

 Sun-SEAT4 78cm(H) 203cm(W) 66cm(D)	 Sun-SEAT4T 78cm(H) 203cm(W) 66cm(D)	 Magazine Table 45cm(W) 45cm(D)
---	--	--











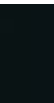



upholstery colours - please specify when ordering

please see inside back cover for full specification of our upholstery range











polypropylene seats

			
black	blue	grey	beige

anti-bacterial vinyl upholstery colours

														
black	grey	beige	primrose	walnut	red wine	salmon	lavender	navy	mid blue	sky blue	cool blue	green	mint	white

anti-bacterial inter/vene™ upholstery colours

									
black	grey	beige	yellow	plum	red	navy	sky blue	green	pastel green

Contemporary range of 4 seat seating modules, which are durable, hygienic and easy to clean. Available in a wide range of colours and anti-bacterial fabrics.



Code: **Sun-SEAT4** - Venus visitor 4 seat module with moulded polypropylene seats
Code: **Sun-SEAT4T** - Venus visitor 3 seat & 1 table module with moulded polypropylene seats



Code: **Sun-SEAT4VYL** - Venus visitor 4 seat module with anti-bacterial vinyl upholstery
Code: **Sun-SEAT4TVYL** - Venus visitor 3 seat & 1 table module with anti-bacterial vinyl upholstery



Code: **Sun-SEAT4IV** - Venus visitor 4 seat module with anti-bacterial inter/vene upholstery
Code: **Sun-SEAT4TIV** - Venus visitor 3 seat & 1 table module with anti-bacterial inter/vene upholstery

product information

 Maximum user weight (17st.) per seat	 Durable moulded polypropylene seats	 Comfortable deep foam upholstered seats	 Rounded/upholstered seat corners	 Vinyl or inter/vene Anti-bacterial upholstery
 Adjustable feet for uneven floors	 Durable silver epoxy coated frame	 Magazine table option	 Minimal assembly required (tools supplied)	 Optional installation service available
 5 year upholstery wearability warranty (inter/vene only)	 2 year warranty on frame and moulded seats	 Easy clean design and materials	 Anti-bacterial Vinyl Strength Test BS EN ISO 13934-1: 2013 BS EN ISO 13973-3: 2000 BS EN ISO 12947-2: 1998	 Anti-bacterial Vinyl Fire (Flammability) Testing Flammability BS 7176 Medium Hazard BS 5852 : 2006 Clause 11 (composites)
 British made				

dimensions

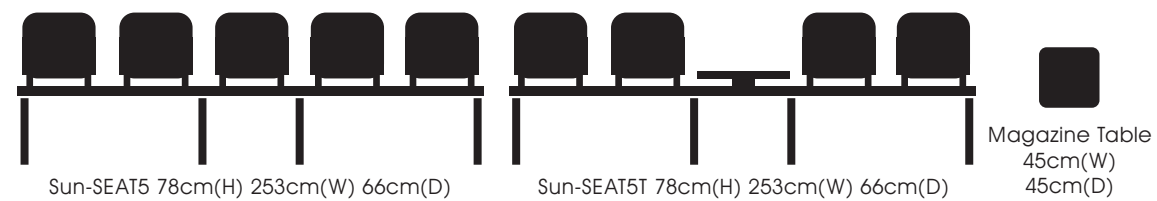

upholstery colours - please specify when ordering

please see inside back cover for full specification of our upholstery range

polypropylene seats



anti-bacterial vinyl upholstery colours

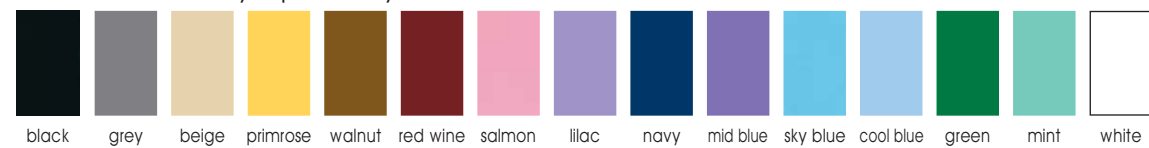

anti-bacterial inter/vene™ upholstery colours

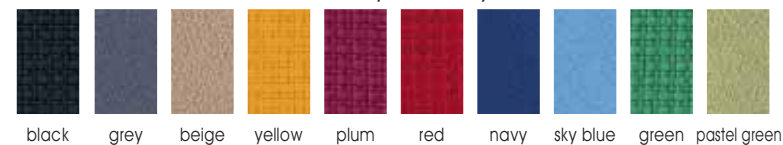

Contemporary range of 5 seat seating modules, which are durable, hygienic and easy to clean. Available in a wide range of colours and anti-bacterial fabrics.



product information - venus visitor chairs

 Maximum user weight (17st.)	 Durable moulded polypropylene seats	 Plastic feet prevent movement/protect floors	 Safe and easy to stack (max. 10 high)	 Supplied fully assembled
 1 year warranty on frame & moulded seats	 Easy clean design and materials	 British made	 Delivery normally within 3-5 working days *	 Chair linking kits available (please see below)

* Please contact us regarding availability for quantities of 10 or more.

product information - galaxy visitor chairs

 Maximum user weight (17st.)	 Comfortable deep foam upholstery	 Rounded/upholstered seat corners	 Safe and easy to stack (max. 5 high)	 Plastic feet prevent movement/protect floors
 Vinyl or inter/vene Anti-bacterial upholstery	 5 year upholstery wearability warranty (inter/vene only)	 1 year warranty on frame	 Supplied fully assembled	 Supplied fully assembled
 Independently tested by FIRA BS EN 16139: 2016 Furniture Strength, Durability and Safety Requirements	 Independently tested by FIRA Anti-bacterial Vinyl Strength Test BS EN ISO 13934-1: 2013 BS EN ISO 13973-3: 2000 BS EN ISO 12947-2: 1998	 Anti-bacterial Vinyl Fire (Flammability) Testing BS EN ISO 13934-1: 2013 BS EN ISO 13973-3: 2000 BS EN ISO 12947-2: 1998 Flammability BS 7176 Medium Hazard BS 5852 : 2006 Clause 11 (composites)	 British made	 Delivery normally within 3-5 working days *

* Please contact us regarding availability for quantities of 10 or more.

upholstery colours - please specify when ordering

please see inside back cover for full specification of our upholstery range

anti-bacterial vinyl upholstery colours



anti-bacterial inter/vene™ upholstery colours

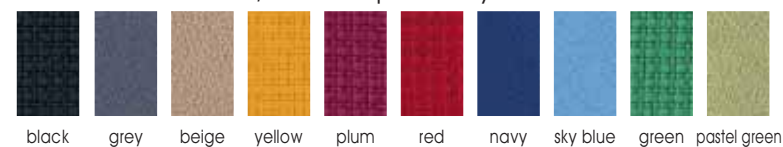

Contemporary range of chairs, which are durable, hygienic and easy to clean, designed for waiting, reception and public areas. Available in a wide range of colours and anti-bacterial fabrics.

Venus Visitor Chairs

Multi-purpose economy chairs, ergonomically designed moulded seats and backs utilise modern materials, combining smooth surfaces, rounded corners with comfort, durability and ease of cleaning.





Code: **Sun-SEAT1** - Venus visitor chair with moulded polypropylene seat

Code: **Sun-SEAT2** - Venus visitor chair and arms with moulded polypropylene seat

Sun-SEAT/LINK1 Chair Linking Kit for Chairs with No Arms

Sun-SEAT/LINK2 Chair Linking Kit for Chairs with Arms

save when buying quantities of **4+**
see price list for details

 79cm(H) 54cm(W) 56cm(D) Seat Height 44cm(H)	Sun-SEAT1 moulded polypropylene black blue grey beige	 79cm(H) 58cm(W) 56cm(D) Seat Height 44cm(H)	Sun-SEAT2 moulded polypropylene black blue grey beige
--	---	--	---

Galaxy Visitor Chairs

Multi-purpose upholstered economy chairs with comfortable deep foam ergonomically designed seat & back.



Code: **Sun-SEAT32VYL** - Galaxy visitor chair in anti-bacterial vinyl upholstery

Code: **Sun-SEAT33VYL** - Galaxy visitor chair with arms in anti-bacterial vinyl upholstery

Code: **Sun-SEAT32IV** - Galaxy visitor chair in anti-bacterial inter/vene upholstery

Code: **Sun-SEAT33IV** - Galaxy visitor chair with arms in anti-bacterial inter/vene upholstery

Sun-SEAT/LINK1 Chair Linking Kit for Chairs with No Arms





Sun-SEAT/LINK2 Chair Linking Kit for Chairs with Arms

save when buying quantities of **3+**
see price list for details

product information - aurora visitor chairs

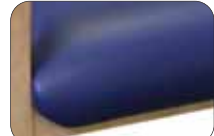
 Maximum user weight (17st.)	 Comfortable deep foam upholstery	 Vinyl or inter/vene Anti-bacterial upholstery	 Solid lacquered beech wood frame	 3 stackable Safe and easy to stack (max. 3 high)
--	---	--	---	---

product information - aurora easy access chairs

 Maximum user weight (17st.)	 Comfortable deep foam upholstery	 Vinyl or inter/vene Anti-bacterial upholstery	 Solid lacquered beech frame	 3 stackable Safe and easy to stack (max. 3 high)
--	---	--	--	---

product information - aurora bariatric chair

 Maximum user weight (34st.)	 Comfortable deep foam upholstery	 Solid beech arms	 Solid beech arms	 Ergonomic design
--	---	---	---	---

additional product information

 5 year upholstery wearability warranty (inter/vene only)	 2 year warranty on frame	 Supplied fully assembled	 Supplied fully assembled	 Independently tested by FIRA BS EN 16139: 2016 Furniture Strength, Durability and Safety Requirements (Sun-SEAT35 & Sun-SEAT36 only)
 Independently tested by FIRA Anti-bacterial Vinyl Strength Test BS EN ISO 13934-1: 2013 BS EN ISO 13973-3: 2000 BS EN ISO 12947-2: 1998	 Anti-bacterial Vinyl Fire (Flammability) Testing Flammability BS 7176 Medium Hazard BS 5852: 2006 Clause 11 (composites)	 British made	 Delivery normally within 3-5 working days */**	* Please contact us regarding availability for quantities of 10 or more. ** Sun-SEAT35, Sun-SEAT36 & Sun-SEAT37 only

upholstery colours - please specify when ordering

please see inside back cover for full specification of our upholstery range

anti-bacterial vinyl upholstery colours



anti-bacterial inter/vene™ upholstery colours

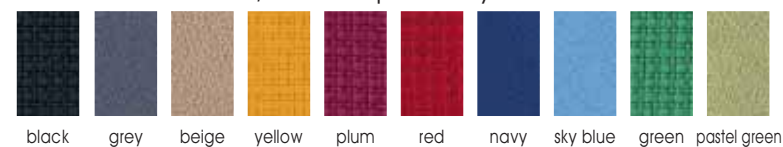

Aurora Visitor Chairs

Deluxe beech frame upholstered chairs with comfortable deep foam padded seat & back, with or without arms.





Code: **Sun-SEAT35VYL** - Aurora visitor chair with anti-bacterial vinyl upholstery

Code: **Sun-SEAT36VYL** - Aurora visitor chair and arms with anti-bacterial vinyl upholstery

Code: **Sun-SEAT35IV** - Aurora visitor chair with anti-bacterial inter/vene upholstery

Code: **Sun-SEAT36IV** - Aurora visitor chair and arms with anti-bacterial inter/vene upholstery

 84cm(H) 51cm(W) 57cm(D) Seat Height 45cm	 84cm(H) 53cm(W) 57cm(D) Seat Height 45cm
--	--



Aurora Easy Access Chairs

The Aurora Easy Access Chair is a range extension to the existing and successful Aurora seating. With an extended squared arm rest to aid in the entry and exit from the chair seat. This is ideal for all users but particularly of use to older or less able visitors.

	 84cm(H) 56cm(W) 57cm(D) Seat Height 48cm
---	--



Code: **Sun-SEAT37VYL** - Aurora easy access chair with arms in anti-bacterial vinyl upholstery

Code: **Sun-SEAT37IV** - Aurora easy access chair with arms in anti-bacterial inter/vene upholstery

Aurora Bariatric Chair

Our Aurora bariatric chair combines strength, stability and comfort with ease of access and is easy to clean.



 88cm(H) 84cm(W) 58cm(D) Seat Width 72cm Seat Height 45cm

Code: **Sun-CHA75VYL** - Aurora Bariatric 222kg (34st.) arm chair with anti-bacterial vinyl upholstery

Code: **Sun-CHA75IV** - Aurora Bariatric 222kg (34st.) arm chair with anti-bacterial inter/vene upholstery

product information

 Maximum user weight (17st.)	 Comfortable deep foam upholstery	 Vinyl or inter/vene Anti-bacterial upholstery	 Solid lacquered beech frame	 Safe and easy to stack (max. 3 high)
 5 year upholstery wearability warranty (inter/vene only)	 2 year warranty on frame	 Supplied fully assembled	 Easy clean design and materials	 BS EN 16139: 2016 Furniture Strength, Durability and Safety Requirements
 Anti-bacterial Vinyl Strength Test BS EN ISO 13934-1: 2013 BS EN ISO 13973-3: 2000 BS EN ISO 12947-2: 1998	 Anti-bacterial Vinyl Fire (Flammability) Testing Flammability BS 7176 Medium Hazard BS 5852: 2006 Clause 11 (composites)	 British made	 Delivery normally within 3-5 working days *	

* Please contact us regarding availability for quantities of 10 or more.

upholstery colours - please specify when ordering

please see inside back cover for full specification of our upholstery range

anti-bacterial vinyl upholstery colours



anti-bacterial inter/vene™ upholstery colours

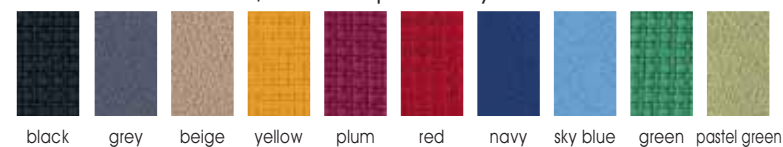

Genesis Chairs

The Genesis Easy Access Chair provides an extended squared arm rest to aid in the entry and exit from the chair seat. This is ideal for all users but particularly of use to older or less able visitors. This easy access feature is combined with an attractive, modern, slightly deeper, square section seat back. The chair is available as a side chair to compliment the arm chair.



Code: **Sun-SEAT41VYL** - Genesis easy access chair in anti-bacterial vinyl upholstery

Code: **Sun-SEAT41IV** - Genesis easy access chair in anti-bacterial inter/vene upholstery

Sun-SEAT41



86cm(H)
56cm(W)
57cm(D)
Seat Height 48cm



Code: **Sun-SEAT42VYL** - Genesis easy access chair with arms in anti-bacterial vinyl upholstery

Code: **Sun-SEAT42IV** - Genesis easy access chair with arms in anti-bacterial inter/vene upholstery

Sun-SEAT42



86cm(H)
56cm(W)
57cm(D)
Seat Height 48cm



product information

 Maximum user weight (17st.)	 Comfortable deep foam upholstery	 Solid beech frame	 Solid beech arms	 Removable seat pad for cleaning
 Optional pressure relieving foam upgrade	 Optional drop-arms to aid lateral transfer (mid & high back chairs)	 Wings for head support (Sun-CHA52 only)	 Optional adjustable height legs (10cm extension)	 Optional house keeping wheels (fitted to rear legs only)
 Vinyl or inter/vene Anti-bacterial upholstery	 5 year upholstery wearability warranty (inter/vene only)	 2 year warranty	 Supplied fully assembled	 Easy clean design and materials
 BS EN 16139: 2016 Furniture Strength, Durability and Safety Requirements	 Anti-bacterial Vinyl Strength Test BS EN ISO 13934-1: 2013 BS EN ISO 13973-3: 2000 BS EN ISO 12947-2: 1998	 Fire (Flammability) Testing Flammability BS 7176 Medium Hazard BS 5852 : 2006 Clause 11 (composites)	 British made	

accessories

* these accessories can only be fitted when ordered with the chair

 Sun-CHA48/PRF Pressure Relieving Foam Upgrade for Seat & Back	 Sun-CHA49/PRF Pressure Relieving Foam Upgrade for Seat & Back	 Sun-CHA50/PRF Pressure Relieving Foam Upgrade for Seat & Back	 Sun-CHA50/AHL* Adjustable Height Legs (10cm extension)	 Sun-CHA50/HKW* House Keeping Wheels (fitted to rear legs only)
--	--	--	---	---

upholstery colours - please specify when ordering

please see inside back cover for full specification of our upholstery range

anti-bacterial vinyl upholstery colours

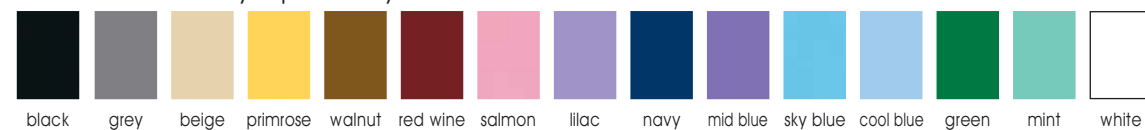

anti-bacterial inter/vene™ upholstery colours

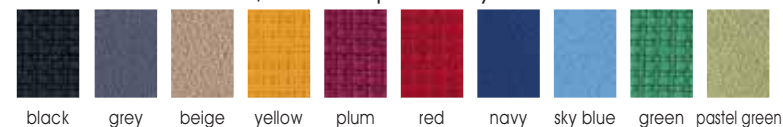

Atlas Patient Arm Chair Range

Deluxe solid beech frame upholstered seating range with deep foam padded seat and back for optimum comfort.



Code: **Sun-CHA48VYL** - Low back side chair with anti-bacterial vinyl upholstery

Code: **Sun-CHA49VYL** - Low back arm chair with anti-bacterial vinyl upholstery

Code: **Sun-CHA48IV** - Low back side chair with anti-bacterial inter/vene upholstery

Code: **Sun-CHA49IV** - Low back arm chair with anti-bacterial inter/vene upholstery



save when buying quantities of 2+ see price list for details





Code: **Sun-CHA50VYL** - Mid back arm chair with anti-bacterial vinyl upholstery

Code: **Sun-CHA50DAVYL** - Mid back arm chair with drop arms in anti-bacterial vinyl upholstery











Code: **Sun-CHA50IV** - Mid back arm chair with anti-bacterial inter/vene upholstery

Code: **Sun-CHA50DAIV** - Mid back arm chair with drop arms in anti-bacterial inter/vene upholstery

dimensions

Sun-CHA48	Sun-CHA49	Sun-CHA50	Sun-CHA50DA
			
94cm(H) 54cm(W) 63cm(D)	94cm(H) 60cm(W) 60cm(D)	104cm(H) 60cm(W) 60cm(D)	104cm(H) 60cm(W) 60cm(D)
Seat Heights 48cm - Internal Seat Widths 49cm			

product information

 Maximum user weight (17st.)	 Comfortable deep foam upholstery	 Solid beech frame	 Solid beech arms	 Removable seat pad for cleaning
 Optional pressure relieving foam upgrade	 Optional drop-arms to aid lateral transfer (mid & high back chairs)	 Wings for head support (Sun-CHA52 only)	 Optional adjustable height legs (10cm extension)	 Optional house keeping wheels (fitted to rear legs only)
 Vinyl or inter/vene Anti-bacterial upholstery	 5 year upholstery wearability warranty (inter/vene only)	 2 year warranty	 Supplied fully assembled	 Easy clean design and materials
 Independently tested by FIRA BS EN 16139: 2016 Furniture Strength, Durability and Safety Requirements	 Independently tested by FIRA Anti-bacterial Vinyl Strength Test BS EN ISO 13934-1: 2013 BS EN ISO 13973-3: 2000 BS EN ISO 12947-2: 1998	 Anti-bacterial Vinyl Fire (Flammability) Testing Flammability BS 7176 Medium Hazard BS 5852 : 2006 Clause 11 (composites)	 British made	

accessories

* these accessories can only be fitted when ordered with the chair

 Sun-CHA51/PRF Pressure Relieving Foam Upgrade for Seat & Back	 Sun-CHA52/PRF Pressure Relieving Foam Upgrade for Seat & Back	 Sun-CHA50/AHL* Adjustable Height Legs (10cm extension)	 Sun-CHA50/HKW* House Keeping Wheels (fitted to rear legs only)
--	--	---	---

upholstery colours - please specify when ordering

please see inside back cover for full specification of our upholstery range

anti-bacterial vinyl upholstery colours

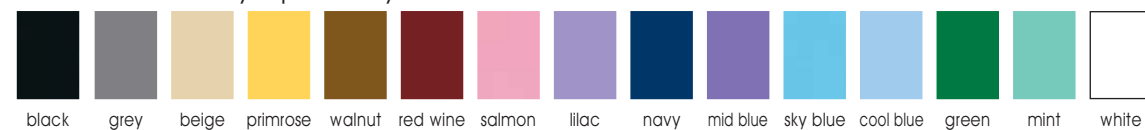

anti-bacterial inter/vene™ upholstery colours

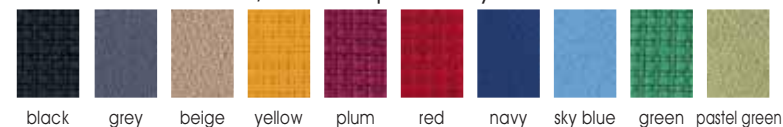

Atlas Patient Arm Chair Range

Deluxe solid beech frame upholstered seating range with deep foam padded seat and back for optimum comfort.



Code: **Sun-CHA51VYL** - High back arm chair with anti-bacterial vinyl upholstery



Code: **Sun-CHA51DAIV** - High back arm chair with drop arms in anti-bacterial inter/vene upholstery

Code: **Sun-CHA51IV** - High back arm chair with anti-bacterial inter/vene upholstery

Code: **Sun-CHA51DAVYL** - High back arm chair with drop arms in anti-bacterial vinyl upholstery



Code: **Sun-CHA52VYL** - High back arm chair with wings in anti-bacterial vinyl upholstery

Code: **Sun-CHA52DAVYL** - High back arm chair with wings and drop arms in anti-bacterial vinyl upholstery

Code: **Sun-CHA52IV** - High back arm chair with wings in anti-bacterial inter/vene upholstery

Code: **Sun-CHA52DAIV** - High back arm chair with wings and drop arms in anti-bacterial inter/vene upholstery





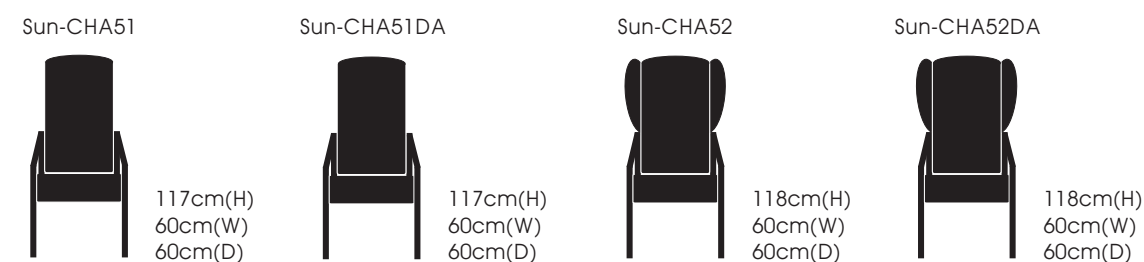







save when buying quantities of 2+ see price list for details

dimensions



Seat Heights 48cm - Internal Seat Widths 49cm

product information

 Maximum user weight (40st.)	 Comfortable deep foam upholstery	 Solid beech frame	 Solid beech arms	 Removable seat pad for cleaning
 Optional pressure relieving foam upgrade	 Optional drop-arms to aid lateral transfer (mid & high back chairs)	 Wings for head support (Sun-CHA56 only)	 Optional adjustable height legs (10cm extension)	 Optional house keeping wheels (fitted to rear legs only)
 Vinyl or inter/vene Anti-bacterial upholstery	 5 year upholstery wearability warranty (inter/vene only)	 2 year warranty	 Supplied fully assembled	 Easy clean design and materials
 Independently tested by FIRA BS EN 16139: 2016 Furniture Strength, Durability and Safety Requirements	 Independently tested by FIRA Anti-bacterial Vinyl Strength Test BS EN ISO 13934-1: 2013 BS EN ISO 13973-3: 2000 BS EN ISO 12947-2: 1998	 Anti-bacterial Vinyl Fire (Flammability) Testing Flammability BS 7176 Medium Hazard BS 5852 : 2006 Clause 11 (composites)	 British made	

accessories * these accessories can only be fitted when ordered with the chair

 Sun-CHA55/PRF Pressure Relieving Foam Upgrade for Seat & Back	 Sun-CHA56/PRF Pressure Relieving Foam Upgrade for Seat & Back	 Sun-CHA50/AHL* Adjustable Height Legs (10cm extension)	 Sun-CHA50/HKW* House Keeping Wheels (fitted to rear legs only)
--	--	---	---

upholstery colours - please specify when ordering

please see inside back cover for full specification of our upholstery range

anti-bacterial vinyl upholstery colours

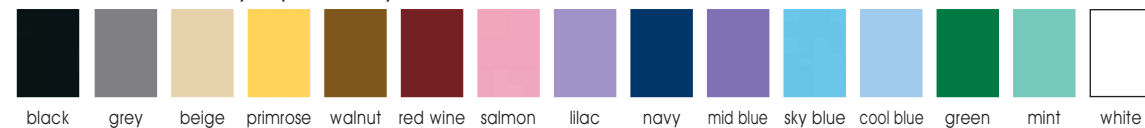

anti-bacterial inter/vene™ upholstery colours

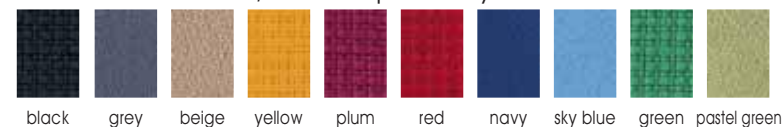

Atlas Bariatric High Back Arm Chair Range

Deluxe solid beech frame upholstered seating range with deep foam padded seat and back for optimum comfort.



Code: **Sun-CHA55VYL** - High back bariatric arm chair with anti-bacterial vinyl upholstery

Code: **Sun-CHA55DAVYL** - High back bariatric arm chair with drop arms in anti-bacterial vinyl upholstery

Code: **Sun-CHA55IV** - High back bariatric arm chair with anti-bacterial inter/vene upholstery

Code: **Sun-CHA55DAIV** - High back bariatric arm chair with drop arms in anti-bacterial inter/vene upholstery



Code: **Sun-CHA56VYL** - High back bariatric arm chair with wings in anti-bacterial vinyl upholstery

Code: **Sun-CHA56DAVYL** - High back bariatric arm chair with wings and drop arms in anti-bacterial vinyl upholstery

Code: **Sun-CHA56IV** - High back bariatric arm chair with wings in anti-bacterial inter/vene upholstery

Code: **Sun-CHA56DAIV** - High back bariatric arm chair with wings and drop arms in anti-bacterial inter/vene upholstery

dimensions

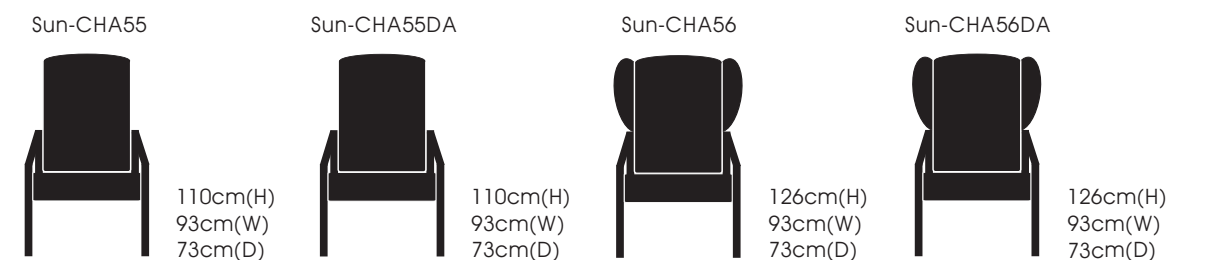

Seat Heights 51cm - Internal Seat Widths 81cm

product information - aurora bariatric chair (Sun-CHA75)

 Maximum user weight (34st.)	 Comfortable deep foam upholstery	 Solid beech arms	 Solid beech arms	 Ergonomic design
 Vinyl or inter/vene Anti-bacterial upholstery	 5 year upholstery wearability warranty (inter/vene only)	 2 year warranty	 Supplied fully assembled	 Easy clean design and materials
 Anti-bacterial Vinyl Strength Test BS EN ISO 13934-1: 2013 BS EN ISO 13973-3: 2000 BS EN ISO 12947-2: 1998	 Anti-bacterial Vinyl Fire (Flammability) Testing Flammability BS 7176 Medium Hazard BS 5852 : 2006 Clause 11 (composites)	 British made		

Bariatric Chairs

Aurora Bariatric Chair

Our Aurora bariatric chair combines strength, stability and comfort with ease of access and is easy to clean.



Code: **Sun-CHA75VYL** - Aurora Bariatric 222kg (34st.) arm chair with anti-bacterial vinyl upholstery

Code: **Sun-CHA75IV** - Aurora Bariatric 222kg (34st.) arm chair with anti-bacterial inter/vene upholstery



88cm(H)
84cm(W)
58cm(D)
Seat Width 72cm
Seat Height 45cm

upholstery colours - please specify when ordering

please see inside back cover for full specification of our upholstery range

anti-bacterial vinyl upholstery colours





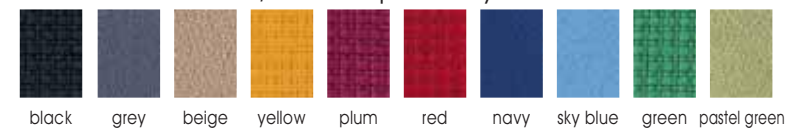

anti-bacterial inter/vene™ upholstery colours



functional
durable
workspace

Desks, Chairs, Filing, Bookcases & Administration Storage











Durable, contemporary and stylish, our premium range of administration furniture, chairs and storage solutions are ideal for today's busy consultation environments. Available in a choice of finishes, all of which are designed to be easy to clean.

	PAGE
 Desks	192-197
 Desk Pedestals & Storage	198-199
 Tambour Units & Storage	200-201
 Filing Cabinets, Bookcases & Storage	202-203
 Consultation Chairs	204-207

product information

 6 widths Available in six widths (80 - 180cm)	 ten finishes Choice of 10 attractive laminate finishes	 Strong & durable 18mm thick desk top (also available in 25mm)	 Stylish silver legs & modesty back panel	 Integrated cable management system
 minimal Minimal assembly required	 eze Easy clean design and materials	 5 year warranty	 British made	

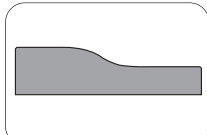
accessories - rectangular desks

 Sun-FPED1 Suspended under desk 2 drawer unit (80cm(D) rectangular desks only)	 Sun-FPED2 Suspended under desk 3 drawer unit (80cm(D) rectangular desks only)	 Sun-UPED1 2 drawer under desk pedestal (80cm(D) rectangular desks only)	 Sun-UPED2 3 drawer under desk pedestal (80cm(D) rectangular desks only)	 Sun-UPED3 4 drawer under desk pedestal (80cm(D) rectangular desks only)
 Sun-HPED8 80cm(D) 2 drawer desk height pedestal	 Sun-HPED9 80cm(D) 3 drawer desk height pedestal	 Sun-HPED10 80cm(D) 4 drawer desk height pedestal	 Sun-DESKWS Wave desktop screens (please enquire)	 Sun-DESKRS Rectangular desktop screens (please enquire)

accessories - rectangular (narrow) desks

 Sun-HPED5 60cm(D) 2 drawer desk height pedestal	 Sun-HPED6 60cm(D) 3 drawer desk height pedestal	 Sun-HPED7 60cm(D) 4 drawer desk height pedestal	 Sun-DESKWS Wave desktop screens (please enquire)	 Sun-DESKRS Rectangular desktop screens (please enquire)
--	--	--	---	--

finishes - please specify when ordering







									
beech	maple	cherry	japanese ash	light oak	modern oak	walnut	white	silver	plain grey

Premium range of desks which are stylish & contemporary in design, strong and durable in construction, suitable for consultation and administration environments. Available in a range of 10 attractive laminate finishes and guaranteed for 5 years.

Rectangular Desks - 74cm(H) x 80cm(D)









dimensions
| 80cm - 180cm(W) |
| 80cm(D) |

 Code: Sun-DESK1/80 80cm wide rectangular desk	 Code: Sun-DESK1/100 100cm wide rectangular desk	 Code: Sun-DESK1/120 120cm wide rectangular desk
 Code: Sun-DESK1/140 140cm wide rectangular desk	 Code: Sun-DESK1/160 160cm wide rectangular desk	 Code: Sun-DESK1/180 180cm wide rectangular desk

Rectangular (Narrow) Desks - 74cm(H) x 60cm(D)



dimensions
| 80cm - 180cm(W) |
| 60cm(D) |

 Code: Sun-DESK2/80 80cm wide rectangular (narrow) desk	 Code: Sun-DESK2/100 100cm wide rectangular (narrow) desk	 Code: Sun-DESK2/120 120cm wide rectangular (narrow) desk
 Code: Sun-DESK2/140 140cm wide rectangular (narrow) desk	 Code: Sun-DESK2/160 160cm wide rectangular (narrow) desk	 Code: Sun-DESK2/180 180cm wide rectangular (narrow) desk

product information

 <p>3 widths</p> <p>Available in three widths (140 - 180cm)</p>	 <p>ten finishes</p> <p>Choice of 10 attractive laminated finishes</p>	 <p>Strong & durable 18mm thick desk top (also available in 25mm)</p>	 <p>Stylish silver legs & modesty back panel</p>	 <p>Integrated cable management system</p>
 <p>Available in left or right hand</p>	 <p>minimal assembly required</p>	 <p>eze Easy clean design and materials</p>	 <p>5 Year Warranty 5 Year Warranty</p>	 <p>British Made Quality Assured</p>

accessories

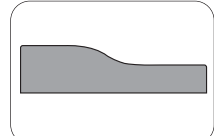
 <p>Sun-FPED1 Suspended under desk 2 drawer unit</p>	 <p>Sun-FPED2 Suspended under desk 3 drawer unit</p>	 <p>Sun-UPED1 2 drawer under desk pedestal</p>	 <p>Sun-UPED2 3 drawer under desk pedestal</p>	 <p>Sun-UPED3 4 drawer under desk pedestal</p>
 <p>Sun-HPED5 60cm(D) 2 drawer desk height pedestal</p>	 <p>Sun-HPED6 60cm(D) 3 drawer desk height pedestal</p>	 <p>Sun-HPED7 60cm(D) 4 drawer desk height pedestal</p>	 <p>Sun-HPED8 80cm(D) 2 drawer desk height pedestal</p>	 <p>Sun-HPED9 80cm(D) 3 drawer desk height pedestal</p>
 <p>Sun-HPED10 80cm(D) 4 drawer desk height pedestal</p>	 <p>Sun-DESKWS Wave desktop screens (please enquire)</p>	 <p>Sun-DESKRS Rectangular desktop screens (please enquire)</p>		

finishes - please specify when ordering



Premium range of desks which are stylish & contemporary in design, strong and durable in construction, suitable for consultation and administration environments. Available in a range of 10 attractive laminate finishes and guaranteed for 5 years.

J Shaped Desks (left hand) - 74cm(H) x 120cm(D)



dimensions

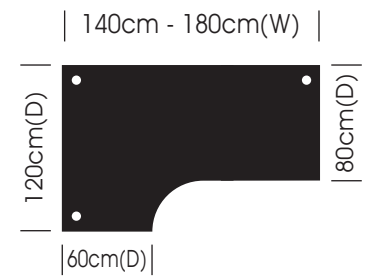

Code: **Sun-DESK5/140**
140cm wide J shaped desk
(left hand)



Code: **Sun-DESK5/160**
160cm wide J shaped desk
(left hand)



Code: **Sun-DESK5/180**
180cm wide J shaped desk
(left hand)

J Shaped Desks (right hand) - 74cm(H) x 120cm(D)



dimensions

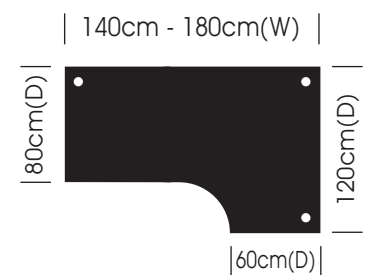

Code: **Sun-DESK6/140**
140cm wide J shaped desk
(right hand)



Code: **Sun-DESK6/160**
160cm wide J shaped desk
(right hand)











Code: **Sun-DESK6/180**
180cm wide J shaped desk
(right hand)

product information - Wave & Symmetrical Desks

 <p>4 widths</p> <p>Wave Desks Available in four widths (120 - 180cm)</p>	 <p>2 widths</p> <p>Symmetrical Desks Available in two widths (140 & 160cm)</p>	 <p>ten finishes</p> <p>Choice of 10 attractive laminated finishes</p>	 <p>Strong & durable 18mm thick desk top (also available in 25mm)</p>	 <p>Stylish silver legs & modesty back panel</p>
 <p>Integrated cable management system</p>	 <p>Available in left or right hand</p>	 <p>minimal assembly required</p>	 <p>Easy clean design and materials</p>	 <p>5 year warranty</p>
 <p>British made</p>				

accessories - Wave & Symmetrical Desks

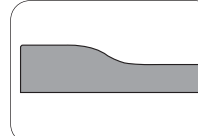
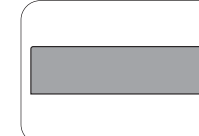
 <p>Sun-FPED1 Suspended under desk 2 drawer unit (Wave desks only)</p>	 <p>Sun-FPED2 Suspended under desk 3 drawer unit (Wave desks only)</p>	 <p>Sun-UPED1 2 drawer under desk pedestal (Wave desks only)</p>	 <p>Sun-UPED2 3 drawer under desk pedestal (Wave desks only)</p>	 <p>Sun-UPED3 4 drawer under desk pedestal (Wave desks only)</p>
 <p>Sun-HPED5 60cm(D) 2 drawer desk height pedestal</p>	 <p>Sun-HPED6 60cm(D) 3 drawer desk height pedestal</p>	 <p>Sun-HPED7 60cm(D) 4 drawer desk height pedestal</p>	 <p>Sun-HPED8 80cm(D) 2 drawer desk height pedestal</p>	 <p>Sun-HPED9 80cm(D) 3 drawer desk height pedestal</p>
 <p>Sun-HPED10 80cm(D) 4 drawer desk height pedestal</p>	 <p>Sun-DESKWS Wave desktop screens (please enquire)</p>	 <p>Sun-DESKRS Rectangular desktop screens (please enquire)</p>		

finishes - please specify when ordering



Premium range of desks which are stylish & contemporary in design, strong and durable in construction, suitable for consultation and administration environments. Available in a range of 10 attractive laminate finishes and guaranteed for 5 years.

Wave Desks (left or right hand) - 74cm(H) x 100cm(D)



dimensions (left Hand)
| 120cm - 180cm(W) |



dimensions (right Hand)
| 120cm - 180cm(W) |



Code: **Sun-DESK7/120** (left hand)
Code: **Sun-DESK8/120** (right hand)
120cm wide wave desk



Code: **Sun-DESK7/140** (left hand)
Code: **Sun-DESK8/140** (right hand)
140cm wide wave desk



Code: **Sun-DESK7/160** (left hand)
Code: **Sun-DESK8/160** (right hand)
160cm wide wave desk



Code: **Sun-DESK7/180** (left hand)
Code: **Sun-DESK8/180** (right hand)
180cm wide wave desk

Symmetrical Desks - 74cm(H)



dimensions

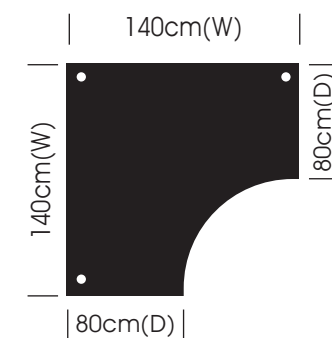

Code: **Sun-DESK9/140**
140cm wide symmetrical desk

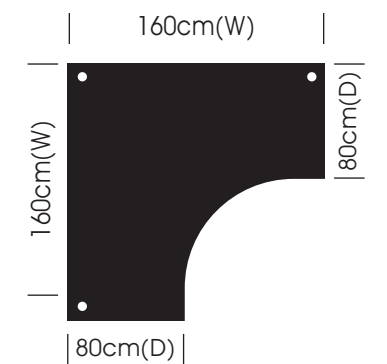

Code: **Sun-DESK9/160**
160cm wide symmetrical desk

product information - fixed under desk pedestals



Suspends underneath desk

2 & 3 drawer options



Single lock, locks all drawers (2 keys supplies)

ten finishes

Choice of 10 finishes

product information - under desk pedestals



Fits underneath desk

2, 3 & 4 drawer options



Single lock, locks all drawers (2 keys supplies)

ten finishes

Choice of 10 finishes

product information - desk height pedestals



Sits along side desk



Two depths 60cm & 80cm

2, 3 & 4 drawer options



Single lock, locks all drawers (2 keys supplies)

ten finishes

Choice of 10 finishes

additional product information



5 year warranty



5 year warranty



Supplied fully assembled



British made

dimensions

Suspended under desk drawer units

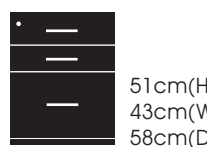

51cm(H)
43cm(W)
58cm(D)

Under desk pedestals



69cm(H)
44cm(W)
55cm(D)

Desk height pedestals



74cm(H)
44cm(W)
60cm(D)

Desk height pedestals



74cm(H)
44cm(W)
80cm(D)

finishes - please specify when ordering



beech maple cherry japanese ash light oak modern oak walnut white silver plain grey

Premium range of storage and filing solutions which are stylish & contemporary in design, strong and durable in construction. Available in a range of 10 attractive laminate finishes and guaranteed for 5 years.

Under desk suspended pedestals - 80cm(D)



Code: Sun-FPED1
2 Drawer fixed under desk pedestal



Code: Sun-FPED2
3 Drawer fixed under desk pedestal



Under desk pedestals - 80cm(D)



Code: Sun-UPED1
2 Drawer under desk pedestal



Code: Sun-UPED2
3 Drawer under desk pedestal



Code: Sun-UPED3
4 Drawer under desk pedestal

Desk height pedestals - 60cm(D)



Code: Sun-HPED5
2 Drawer desk height pedestal



Code: Sun-HPED6
3 Drawer desk height pedestal



Code: Sun-HPED7
4 Drawer desk height pedestal

Desk height pedestals - 80cm(D)



Code: Sun-HPED8
2 Drawer desk height pedestal



Code: Sun-HPED9
3 Drawer desk height pedestal



Code: Sun-HPED10
4 Drawer desk height pedestal

product information - tambour units



Adjustable height shelves



Locking roller doors (2 keys supplied)



Choice of 10 finishes

product information - desk height side filing cabinet



Holds files and folders



Two locking drawers (2 keys supplied)



Anti-tilt castor feature



Sits along side desk



Choice of 10 finishes

product information - desk height base unit



One adjustable height shelf



Locking door (2 keys supplied)



Choice of 10 finishes

additional product information



5 year warranty



5 year warranty



Supplied fully assembled



British made

dimensions

Tall Tambour Units

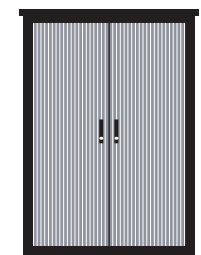

110cm(W) 53cm(D)

Desk height tambour unit

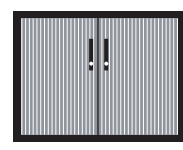

74cm(H) 80cm(W) 60cm(D)

Corner tambour unit

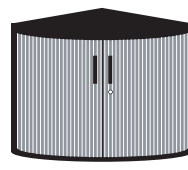

74cm(H) 80cm(W) 60cm(D)

Desk height side filing cabinet

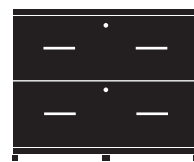

74cm(H) 80cm(W) 60cm(D)

Desk height base unit

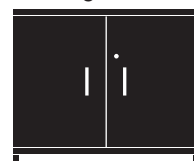

74cm(H) 80cm(W) 60cm(D)

finishes - please specify when ordering



Premium range of storage and filing solutions which are stylish & contemporary in design, strong and durable in construction. Available in a range of 10 attractive laminate finishes and guaranteed for 5 years.

Tall tambour units



- Code: **Sun-TAMBOUR2**
120cm(H) Tambour unit - 2 shelves
- Code: **Sun-TAMBOUR3**
160cm(H) Tambour unit - 3 shelves
- Code: **Sun-TAMBOUR4**
180cm(H) Tambour unit - 3 shelves

Desk height tambour unit



Code: **Sun-TAMBOUR1**
Desk height tambour unit - 1 shelf

Corner tambour unit



Code: **Sun-TAMBOUR7**
Corner tambour unit - 1 shelf

Desk height side filing cabinet



Code: **Sun-FCAB1** - Side filing cabinet

Desk height base unit



Code: **Sun-SCAB1** - Desk height base unit

product information - document file organiser/sorter



15 individual compartments (Document Organiser)



9 or 18 individual compartments (Document sorter)

suitable for files or paper

Accommodates A4 size paper



FIRA Standard 6250 2005 Specification: Adhesion Performance General/Severe



5 year warranty



Supplied fully assembled



British made

product information - filing cabinets

anti-tilt design



Available in 3 sizes



Single lock, locks all drawers (2 keys supplies)



5 year warranty



Supplied fully assembled



British made

product information - bookcases

5 sizes available

All with adjustable height shelves



FIRA Standard 6250 2005 Specification: Adhesion Performance General/Severe



5 year warranty



Supplied fully assembled



British made

dimensions

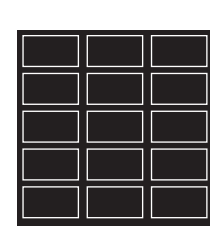

Document File Organiser
110cm(H) 80cm(W) 33cm(D)
Individual Compartments
19.5cm(H) 24cm(W) 30.5cm(D)

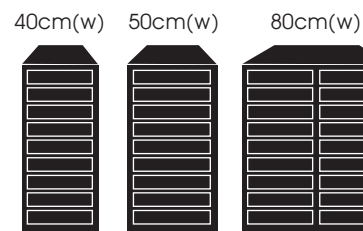

Document Sorters
107cm(H) 30cm(D)
Individual Compartments
8cm(H) 36cm(W) 28cm(D)

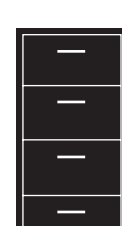

Filing Cabinets
48cm(W) 66cm(D)



Bookcases
80cm(W) 41cm(D)

finishes - please specify when ordering



beech maple cherry japanese ash light oak modern oak walnut white silver plain grey

Premium range of storage and filing solutions which are stylish & contemporary in design, strong and durable in construction. Available in a range of 10 attractive laminate finishes and guaranteed for 5 years.

Document file organiser/sorters



Code: **Sun-DOC1**
Document organiser



Code: **Sun-WUSHMDH40-LH**
40cm wide document sorter with sloping top (Left Hand)



Code: **Sun-WUSHMDH50-LH**
50cm wide document sorter with sloping top (Left Hand)



Code: **Sun-WUSHMDH80**
80cm wide document sorter, sloping top with 2 doors

Code: **Sun-WUSHMDH40-RH**
40cm wide Document sorter with sloping top (Right Hand)

Code: **Sun-WUSHMDH50-RH**
50cm wide Document sorter with sloping top (Right Hand)

Filing cabinets



Code: **Sun-FCAB2**
74cm(H) Filing cabinet
2 drawers



Code: **Sun-FCAB3**
105cm(H) Filing cabinet
3 drawers



Code: **Sun-FCAB4**
136cm(H) Filing cabinet
4 drawers

Bookcases



Code: **Sun-BOOK5**
200cm(H) Bookcase
4 shelves



Code: **Sun-BOOK4**
180cm(H) Bookcase
3 shelves



Code: **Sun-BOOK3**
160cm(H) Bookcase
3 shelves







Code: **Sun-BOOK2**
120cm(H) Bookcase
2 shelves







Code: **Sun-BOOK1**
74cm(H) Bookcase
1 shelf

product information

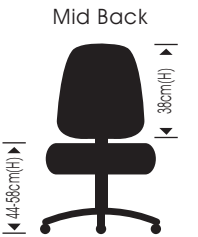
 Maximum user weight (20st.)	 Vinyl or inter/vene Anti-bacterial upholstery	 Gas-lift seat height adjustment	 Adjustable height range	 Mid or high back chairs available
 Twin levers adjust seat height & back angle	 Optional fixed arms	 Five star chrome base	 Five star black nylon base	 Tested by FIRA to comply with BS EN 1335 2&3: 2009
 Independently tested by FIRA Anti-bacterial Vinyl Strength Test BS EN ISO 13934-1: 2013 BS EN ISO 13973-3: 2000 BS EN ISO 12947-2: 1998	 Anti-bacterial Vinyl Fire (Flammability) Testing Flammability BS 7176 Medium Hazard BS 5852: 2006 Clause 11 (composites)	 5 year upholstery wearability warranty (inter/vene only)	 Easy clean design and materials	 5 year warranty
 British made				

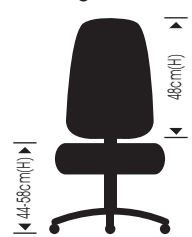
dimensions

 44 - 58cm(H) Seat Width 48cm Base 60cm Ø	 44 - 58cm(H) Seat Width 48cm Base 60cm Ø	 44 - 58cm(H) Seat Width 48cm Base 60cm Ø	 44 - 58cm(H) Seat Width 48cm Base 60cm Ø
---	---	---	--

upholstery colours - please specify when ordering

please see inside back cover for full specification of our upholstery range

anti-bacterial vinyl upholstery colours

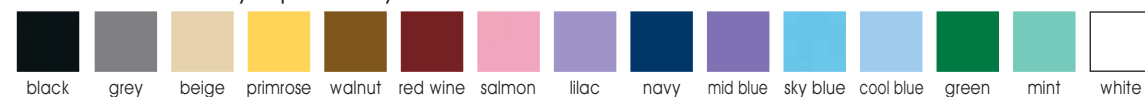

anti-bacterial inter/vene™ upholstery colours

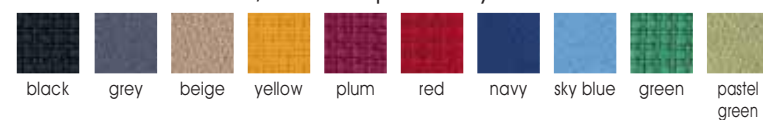

Premium range of fully adjustable consultation chairs, suitable for daily use in healthcare environments. Available in vinyl or inter/vene anti-bacterial upholstery.

Solitaire Chairs (Mid Back)

Mid back, twin lever consultation chairs with five star castor base.



- | | | | |
|--|--|---|--|
| Code: Sun-CHA20VYL/M
Consultation chair in anti-bacterial vinyl upholstery | Code: Sun-CHA20VYL/MS
Consultation chair with chrome base in anti-bacterial vinyl upholstery | Code: Sun-CHA20VYL/MA
Consultation chair with arms in anti-bacterial vinyl upholstery | Code: Sun-CHA20VYL/MSA
Consultation chair with arms and chrome base in anti-bacterial vinyl upholstery |
| Code: Sun-CHA20IV/M
Consultation chair in anti-bacterial inter/vene upholstery | Code: Sun-CHA20IV/MS
Consultation chair with chrome base in anti-bacterial inter/vene upholstery | Code: Sun-CHA20IV/MA
Consultation chair with arms in anti-bacterial inter/vene upholstery | Code: Sun-CHA20IV/MSA
Consultation chair with arms and chrome base in anti-bacterial inter/vene upholstery |

Solitaire Chairs (High Back)

High back, twin lever consultation chairs with five star castor base.



- | | | | |
|--|--|---|--|
| Code: Sun-CHA21VYL/H
Consultation chair in anti-bacterial vinyl upholstery | Code: Sun-CHA21VYL/HS
Consultation chair with chrome base in anti-bacterial vinyl upholstery | Code: Sun-CHA21VYL/HA
Consultation chair with arms in anti-bacterial vinyl upholstery | Code: Sun-CHA21VYL/HSA
Consultation chair with arms and chrome base in anti-bacterial vinyl upholstery |
| Code: Sun-CHA21IV/H
Consultation chair in anti-bacterial inter/vene upholstery | Code: Sun-CHA21IV/HS
Consultation chair with chrome base in anti-bacterial inter/vene upholstery | Code: Sun-CHA21IV/HA
Consultation chair with arms in anti-bacterial inter/vene upholstery | Code: Sun-CHA21IV/HSA
Consultation chair with arms and chrome base in anti-bacterial inter/vene upholstery |

product information

 Maximum user weight (20st.)	 Vinyl or inter/vene Anti-bacterial upholstery	 Gas-lift seat height adjustment	 Gas assisted adjustable height	 Three levers adjust seat height, seat tilt & back angle
 Independent controlled seat slide	 Adjustable lumbar support (Sun-CHA23/EAALC only)	 Fixed arms	 Adjustable arms	 Five star chrome base
 Designed for 24hr usage	 Tested by FIRA to comply with BS EN 1335 2&3: 2009	 Anti-bacterial Vinyl Strength Test BS EN ISO 13934-1: 2013 BS EN ISO 13973-3: 2000 BS EN ISO 12947-2: 1998	 Fire (Flammability) Testing Flammability BS 7176 Medium Hazard BS 5852 : 2006 Clause 11 (composites)	 5 year upholstery wearability warranty (inter/vene only)
 Easy clean design and materials	 5 year warranty	 British made		

dimensions

No Arms	Fixed Arms	Adjustable Arms	Adjustable Arms & Lumbar
 46 - 58cm(H) Seat Width 50cm Base 60cm Ø	 46 - 58cm(H) Seat Width 50cm Base 60cm Ø	 46 - 58cm(H) Seat Width 50cm Base 60cm Ø	 46 - 58cm(H) Seat Width 50cm Base 60cm Ø

upholstery colours - please specify when ordering

please see inside back cover for full specification of our upholstery range

anti-bacterial vinyl upholstery colours



anti-bacterial inter/vene™ upholstery colours

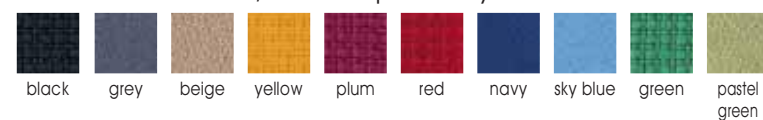

Premium range of fully adjustable consultation chairs, suitable for daily use in healthcare environments. Available in vinyl or inter/vene anti-bacterial upholstery.

Quasar Deluxe Chairs

Executive high back, three lever consultation chairs with chrome five star castor base, fixed or adjustable arms with optional lumbar support.



Code: **Sun-CHA23VYL/EC**
Deluxe consultation chair in anti-bacterial vinyl upholstery

Code: **Sun-CHA23IV/EC**
Deluxe consultation chair in anti-bacterial inter/vene upholstery



Code: **Sun-CHA23VYL/EAC**
Deluxe consultation chair with fixed arms in anti-bacterial vinyl upholstery

Code: **Sun-CHA23IV/EAC**
Deluxe consultation chair with fixed arms in anti-bacterial inter/vene upholstery



Code: **Sun-CHA23VYL/EAAC**
Deluxe consultation chair with adjustable arms in anti-bacterial vinyl upholstery

Code: **Sun-CHA23IV/EAAC**
Deluxe consultation chair with adjustable arms in anti-bacterial inter/vene upholstery











Code: **Sun-CHA23VYL/EAALC**
Deluxe consultation chair with adjustable arms and lumbar support in anti-bacterial vinyl upholstery

Code: **Sun-CHA23IV/EAALC**
Deluxe consultation chair with adjustable arms and lumbar support in anti-bacterial inter/vene upholstery

effective
ergonomic
design

Drug, Medicine, Records Trolleys & Pharmacy Fridges

Designed to provide a complete solution for securely storing, distributing and dispensing medicines and controlled drugs. Our range complies with all the required standards and guidelines and are independently tested for your peace of mind.

	PAGE
 Unit Dosage System (UDS) Trolleys	209-210
 Monitored Dosage System (MDS) Trolleys	211-212
 new EPMA Ward Drug & Medicine Dispensing Trolleys	213-214
 Ward Drug & Medicine Dispensing Trolleys	215-216
 Medical Notes Trolleys	217-218
 Record Transfer Trolleys	219-220
 BIODOSE Medicine Dispensing Trolleys	221-222
 Pharmacy Fridges	223-224

product information - (DT8/UDS Trolley)



9 wide trays and 9 tray dividers



18 narrow trays and 18 tray dividers



Trays provides 54 compartments



6 adjustable height door shelves



Pull-out clear A4 storage tray

product information - (DT7/UDS Trolley)



6 wide trays and 6 tray dividers



12 narrow trays and 12 tray dividers



Trays provides 36 compartments



3 adjustable height door shelves

additional product information



6 pull-out shelves with finger recess



Fold down work surface



Slam lock with 2 keys & lock escutcheon



Integrated cup, pill cup, water jug and pen recess



Integral shelf for patient records file



Push and pull handles, bin & medi-rail



All-round protective rail & front braked castors



Easy clean design and materials



FIRA Standard 6250 2005 Specification: Adhesion Performance General/Severe



FSC The mark of responsible forestry



2 year warranty



British made

accessories * these accessories can only be fitted when ordered with the trolley



Sun-DT/KEY* Additional Door Key



Sun-DT/SL1 Security Leash & Wall Fixing Bracket



Sun-DT/B25* Additional 2.5 Litre Bin and Bracket



Sun-DT/AGH1* Alcohol Gel Holder



Sun-DT/WT Additional Wide Tray



Sun-DT/WTD Additional Wide Tray Divider (each)



Sun-DT/WTL Additional Wide Tray Labels (10 pack)



Sun-DT/NT Additional Narrow Tray



Sun-DT/NTD Additional Narrow Tray Divider (each)



Sun-DT/NTL Additional Narrow Tray Labels (10 pack)

Stylish & contemporary in design, strong, secure and durable in construction, unit dosage drug trolleys are the ideal solution for storing, distributing and dispensing medicines and patient prescriptions. Hygienically designed and finished in attractive beech effect laminate which is easy to clean.



Code: **Sun-DT8/UDS**
Unit dosage system (UDS) trolley - large



Sun-DT7/UDS
112cm(H)
62cm(W)
60cm(D)























Code: **Sun-DT7/UDS**
Unit dosage system (UDS) trolley - small



Sun-DT8/UDS
112cm(H)
82cm(W)
60cm(D)

product information

 Pull-out shelves with finger recess	 Location channel for holding racks	 Fold down work surface	 3 adjustable height door shelves (DT1/MDS4 DT1/MDS6)	 6 adjustable height door shelves (DT2/MDS9)
 Pull-out clear A4 storage tray (DT2/MDS9)	 Slam lock with 2 keys & lock escutcheon	 Integrated cup, pill cup & water jug recesses	 Integrated pen recess	 Push and pull handles, bin & medi-rail
 All-round protective rail	 Front push and pull handle	 100mm Castors with front brakes	 Integral shelf for patients record file	 Easy clean design and materials
 Independently tested by FIRA FIRA Standard 6250 2005 Specification: Adhesion Performance General/Severe	 FSC The mark of responsible forestry	 2 year warranty	 Supplied fully assembled	 British made

accessories

* these accessories can only be fitted when ordered with the trolley



 Sun-DT/KEY* Additional Door Key	 Sun-DT/SL1 Security Leash & Wall Fixing Bracket	 Sun-DT/B25* Additional 2.5 Litre Bin and Bracket	 Sun-DT/AGH1* Alcohol Gel Holder	 MDS Self Administration Cabinets (see pages 122-123)
---	---	--	---	--



MDS Medicine Cabinets
(see pages 122-123)

- Cards, racks and blister packs are supplied by the pharmacist

dimensions

Sun-DT1/MDS4  112cm(H) 62cm(W) 60cm(D)	Sun-DT1/MDS6  112cm(H) 62cm(W) 60cm(D)	Sun-DT2/MDS9  112cm(H) 82cm(W) 60cm(D)
---	---	--

Stylish & contemporary in design, strong, secure and durable in construction, monitored dosage drug trolleys are the ideal solution for storing, distributing and dispensing medicines and patient prescriptions stored in blister packs, as supplied by Boots & Venalink. Hygienically designed and finished in attractive beech effect laminate which is easy to clean.



Code: Sun-DT2/MDS9
Monitored dosage system (MDS) trolley - large 9 racks



Code: Sun-DT1/MDS6
Monitored dosage system (MDS) trolley - small 6 racks



Code: Sun-DT1/MDS4
Monitored dosage system (MDS) trolley - small 4 racks



product information

Adhesion Performance General/Severe

*** Keyed to differ as specified by NHS England - (keyed to differ means each trolley has its own unique set of keys)

accessories

* these accessories can only be fitted when ordered with the trolley ** includes medi-rail

The NHS is targeted to be paperless by 2020...



...the Sunflower Medical Ward Drug Trolley Range forms part of the EPMA Solution.

The trolleys are designed to provide a complete solution for storing, distributing & dispensing medicine & drugs. Aesthetically pleasing, hygienically designed and combining smart adjustable internal storage with easy access, all trolleys are functional, strong, secure & easy to clean.

Our EPMA Ward Drug Trolleys are available in three sizes, small, medium and large, each size has four options to choose from giving you greater flexibility for your specific needs.

Code: **Sun-EPMA1/LAPTOP/BOX/WHITE** (Shown)
SMALL EPMA Ward Drug Trolley with Laptop Arm and Bracket, Tray and 1 Secure Bottom Storage Cabinet - White Dispensing Cupboard Doors

128cm(H)
64cm(W)
58cm(D)
67cm(W) 60cm(D) including buffers

Code: **Sun-EPMA5/LAPTOP/BOX/WHITE** (Shown)
MEDIUM EPMA Ward Drug Trolley with Laptop Arm and Bracket, Trays and 1 Secure Bottom Storage Cabinet - White Dispensing Cupboard Doors

128cm(H)
78cm(W)
58cm(D)
81cm(W) 60cm(D) including buffers



dispensing door colours

(please specify when ordering)
see inside back cover for full specification of our KYDEX® range

Code: **Sun-EPMA11/LAPTOP/TRAYS/WHITE** (Shown)
LARGE EPMA Ward Drug Trolley with Laptop Arm and Bracket, Trays and Bottom Shelf - White Dispensing Cupboard Doors

128cm(H)
90cm(W)
58cm(D)
94cm(W) 60cm(D) including buffers

product information

 Lightweight easy to manoeuvre design	 Adjustable shelf divider system provides upto 5 compartments per shelf	 Adjustable cabinet base divider system provides upto 16 compartments	 Hinged lid with slam lock & protective lock escutcheon	 Lock supplied with 2 keys (Keyed to differ)***
 Shelf labels supplied	 Gas assisted lid opening & retention	 Hygienic stainless steel handle and fittings	 Fold down work surface	 Lift up side table
 4 removable tray positions (2 trays supplied)	 Patient notes/file retention strap	 Push pull handle (to 3 sides)	 Four 100mm braked castors with four protective buffers	 Security Leash & Wall Fixing Bracket
 Laminate faced MDF with 2mm edging	 Easy clean design and materials	 FIRA Standard 6250 2005 Specification: Adhesion Performance General/Severe	 FSC The mark of responsible forestry	 2 year warranty
 Supplied fully assembled	 British made			

*** Keyed to differ as specified by NHS England - (keyed to differ means each trolley has its own unique set of keys)

accessories

* these accessories can only be fitted when ordered with the trolley ** includes medi-rail

 Sun-WDT/T2B Additional Double Depth Wide Tray (blue)	 Sun-WDT/4Y Additional Double Depth Narrow Tray (yellow)	 Sun-WDT/KD/KEY* Additional Keys	 Sun-WDT/SBOX1 ** Sharps Box Bracket (Daniels - All Sizes)	 Sun-WDT/SBOX2 ** Sharps Box Bracket (Frontier) Upto 1 Litre
 Sun-WDT/SBOX3 ** Sharps Box Bracket (Frontier) 2 & 3 Litre	 Sun-WDT/DIV1 Additional Divider Kit (5 Shelf Dividers, 10 Base Dividers, 10 Labels and 5 Clips)	 Sun-WDT/AGH1 ** Alcohol Gel Holder	 Sun-WDT/GBH1 ** Glove Box Holder	 Sun-LC3A * Antistatic Braked Castors

Designed to provide a complete solution for storing, distributing and dispensing medicine and drugs. Ward drug & medicine dispensing trolleys are aesthetically pleasing, hygienically designed and combine smart adjustable internal storage with easy access, while being functional, strong, secure and easy to clean.



Code: **Sun-WDT20/KD**
Ward drug & medicine dispensing trolley (medium capacity) with divider system and 2 storage trays



Sun-WDT20/KD
Wide/Double Depth Trays
16cm(H) 47cm(W) 42cm(D)
Narrow/Double Depth Trays
16cm(H) 31cm(W) 42cm(D)
NB: Maximum tray load 7.5kg
110cm(H) 90cm(W) 58cm(D)
94cm(W) 60cm(D) with buffers



Adjustable storage divider system on shelves and cabinet base



Keyed to Differ as required by NHS England



Code: **Sun-WDT50/KD**
Ward drug & medicine dispensing trolley (large capacity) with divider system and 2 storage trays



Sun-WDT50/KD
Wide/Double Depth Trays
16cm(H) 47cm(W) 42cm(D)
Narrow/Double Depth Trays
16cm(H) 31cm(W) 42cm(D)
NB: Maximum tray load 7.5kg
128cm(H) 90cm(W) 58cm(D)
94cm(W) 60cm(D) with buffers

product information

 Lightweight easy to manoeuvre design	 Secure locking top 2 keys per lock (keyed to differ)***	 Digital locking system	 Secure solid sides and base	 Accepts foolscap or X-Ray size filing pockets (not included)**
 Accepts 470mm & 360mm filing pockets (not included)**	 Filing pocket identification label for easy re-ordering	 Wipe clean filing pocket tabs (supplied with pockets)	 Hinged top(s) open to create additional working space	 Hygienic stainless steel handles
 2 or 4 removable storage trays	 Side storage for patients record file	 Push pull handles	 Four 100mm braked castors	 Four protective buffers
 Durable laminate faced MDF with 2mm edging	 Easy clean design and materials	 FIRA Standard 6250 2005 Specification: Adhesion Performance General/Severe	 FSC The mark of responsible forestry	 2 year warranty
 Supplied fully assembled	 British made			

*** Keyed to differ as specified by NHS England - (keyed to differ means each trolley has its own unique set of keys)

accessories

* these accessories can only be fitted when ordered with the trolley

 Sun-LC3A * Antistatic Braked Castors	 Sun-MNT/DCL/KEY* Overriding Key for Digital Locking System	 Sun-MNT/FPF/PK10 Filing Pocket Foolscap 360mm(W) x 270mm(D) (Pack of 10)	 Sun-MNT/WFPF/PK10 Wide Filing Pocket Foolscap 450mm(W) x 270mm(D) (Pack of 10)	 Sun-MNT/FPX/PK10 Filing Pocket X-Ray 360mm(W) x 470mm(D) (Pack of 10)
 Sun-MNT/WFPX/PK10 Wide Filing Pocket X-Ray 450mm(W) x 470mm(D) (Pack of 10)	 Sun-MNT/FPXF/PK10 Twin Filing Pocket X-Ray & Foolscap 360mm(W) x 270/470mm(D) (Pack of 10)	 Sun-MNT/WFPXF/PK10 Twin Wide Filing Pocket X-Ray & Foolscap 450mm(W) x 270/470mm(D) (Pack of 10)		

** Sun-MNT10 & Sun-MNT10/DCL
Trolley can accept all filing pocket sizes but cannot be combined together.

** Sun-MNT20 & Sun-MNT20/DCL
Trolley can accept all filing pocket sizes which can be used together but only in opposite sides of the trolley.

Designed to provide a complete solution for storing, distributing and accessing medical notes and X-Rays. Medical notes trolleys are aesthetically pleasing, hygienically designed and combine smart adjustable filing pockets with easy access, while being functional, strong, secure and easy to clean.



Code: **Sun-MNT10**
Medical Notes Trolley, enclosed sides with hinged locking top (Shown)

Code: **Sun-MNT10/DCL**
Medical Notes Trolley, enclosed sides with hinged top and 1 Digital Combination Lock



Optional Digital locking system with optional overriding key (override key(s) must be ordered with trolley)

Sun-MNT10 & 10/DCL



Wide/Single Depth Trays
8cm(H) 47cm(W) 42cm(D)

Wide/Double Depth Trays
16cm(H) 47cm(W) 42cm(D)

NB: Maximum tray load 7.5kg

106cm(H) 64cm(W) 52cm(D)
66cm(W) 57cm(D) with buffers



Keyed to Differ as required by NHS England



Code: **Sun-MNT20**
Medical Notes Trolley, enclosed sides with hinged locking tops (Shown)

Code: **Sun-MNT20/DCL**
Medical Notes Trolley, enclosed sides with hinged top and 2 Digital Combination Locks

Sun-MNT20 & 20/DCL























Wide/Single Depth Trays
8cm(H) 47cm(W) 42cm(D)

Wide/Double Depth Trays
16cm(H) 47cm(W) 42cm(D)

NB: Maximum tray load 7.5kg



106cm(H) 121cm(W) 52cm(D)
121cm(W) 57cm(D) with buffers

product information

				
Lightweight easy to manoeuvre design	Secure locking top (Sun-MRTTL1 only)	Lock is provided with 2 keys (keyed to differ)***	Locking top folds neatly back	Hygienic stainless steel handle
				
Maximum load 60kg	Strong deep cabinet for optimum file storage	Easy access to files and documents	2 removable storage trays	Secure solid sides and base
				
Push pull handles	Durable powder coated blue frame	100mm castors (2 braked)	Four protective buffers	Durable laminate faced MDF with 2mm edging
				
Easy clean design and materials	FIRA Standard 6250 2005 Specification: Adhesion Performance General/Severe	FSC The mark of responsible forestry	2 year warranty	Supplied fully assembled
	British made			

*** Keyed to differ as specified by NHS England - (keyed to differ means each trolley has its own unique set of keys)

accessories * these accessories can only be fitted when ordered with the trolley

	
Sun-LC3A * Antistatic Braked Castors	Sun-MRTT/KEY* Additional Key

dimensions

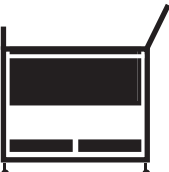
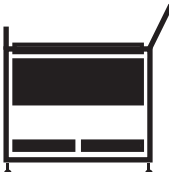
		<p>Narrow/Single Depth Trays 8cm(H) 31cm(W) 42cm(D)</p> <p>NB: Maximum tray load 7.5kg</p> <p>Storage Box (internal) 25cm(H) 62cm(W) 40cm(D)</p>
Sun-MRTT1 98cm(H) 81cm(W) 52cm(D) 83cm(W) 57cm(D) with buffers	Sun-MRTTL1 98cm(H) 81cm(W) 52cm(D) 83cm(W) 57cm(D) with buffers	

Designed to provide a complete solution for storing, distributing and transferring medical notes and files quickly to different locations. Records transfer trolleys are aesthetically pleasing, hygienically designed and easy to access, while being functional, strong, secure and easy to clean.



Code: Sun-MRTT1
Records Transfer Trolley - open



Code: Sun-MRTTL1
Records Transfer Trolley - with folding locking top

product information

 Holds 72 BIODOSE trays	 Individual tray slots with easy access	 6 height adjustable door trays	 High security 8 lever lock designed to EN1300 and Vds 2396	 4 keys supplied as standard, additional keys available
 Protective lock escutcheon	 Flush fitting recessed door handles	 Side push and pull handle	 All-round protective rail	 Large durable worktop area
 Side storage for patient records file	 Integrated clip board clasp	 Security leash and wall fixing bracket	 Durable white MFC panels with 2mm edging	 100mm castors with front brakes
 Easy clean design and materials	 FIRA Standard 6250 2005 Specification: Adhesion Performance General/Severe	 FSC The mark of responsible forestry	 3 year warranty	 Supplied fully assembled
 British made				

accessories

 Sun-BIO/DT69/TRAY Pull Out Storage Tray (fills 2 slots)	 Sun-BIO/MK2/KEY Additional key	 Sun-BIO/MK2/DOORTRAY Additional door tray	 BIODOSE Cabinet Range (see pages 124-125)
--	---	--	--

dimensions



112cm(H)
92cm(W)
55cm(D)

Stylish & contemporary in design, strong, secure and durable in construction, BIODOSE medicine dispensing trolleys are the ideal solution for storing, distributing and dispensing medicines in BIODOSE trays. Aesthetically pleasing design which is functional, durable and easy to clean.



Code: Sun-BIO/MK2/DT69
BIODOSE medicine dispensing trolley - holds upto 72 trays



product information

 5 sizes/capacities available	 Wall mounting, worktop mounted, under worktop or freestanding	 Lockable doors (2 keys supplied)	 Hi-Low temperature & door open alarm	 Via battery backup
 Off cycle automatic defrost	 ECO friendly refrigerant	 DH Green Book & RPSGB/GPhC compliant	 Fan assisted air cooling for rapid temperature recovery	 Internal light fitted as standard on all models
 Temperature range 2°C to 8°C	 Glass doors for visible stock control	 Real time temperature display	 Min/max temperature recording	 Accurate temperature control
 Solid doors provide extra security	 Temperature data storage	 Adjustable shelves	 White painted corrosion proof aluminium interior	 Low energy consumption
 Easy clean design and materials	 5 year warranty *	 Supplied fully assembled	 British made	

* 5 year warranty upon registration by the end user (UK only) 1 year warranty for export orders

dimensions

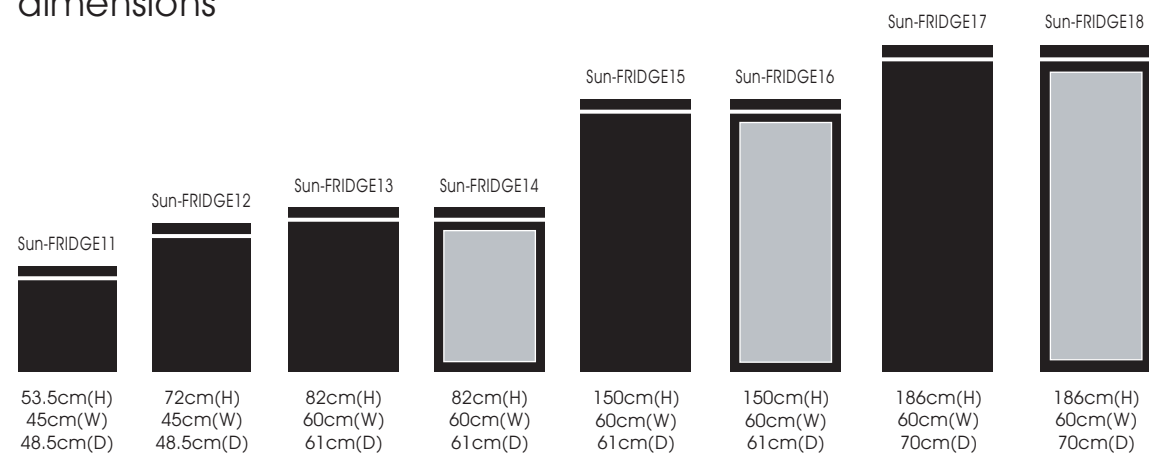

Designed specifically to meet the demands of health care professionals and for the storage of temperature sensitive vaccines and pharmaceuticals in accordance with manufacturers licensed temperature ranges and guidance. Low energy use, fan assisted cooling, flexible shelving and a 5 year warranty all come as standard.



Code: **Sun-FRIDGE11**
36 Litre wall/worktop mounted fridge - 2 shelves



Code: **Sun-FRIDGE12**
66 Litre wall/worktop mounted fridge - 3 shelves



Code: **Sun-FRIDGE13**
150 Litre under worktop fridge - 3 shelves



Code: **Sun-FRIDGE14**
150 Litre under worktop, glass door fridge - 3 shelves



Code: **Sun-FRIDGE15**
300 Litre free standing fridge - 6 shelves
Code: **Sun-FRIDGE17** (not shown)
430 Litre free standing fridge - 6 shelves











Code: **Sun-FRIDGE16**
300 Litre free standing, glass door fridge - 6 shelves
Code: **Sun-FRIDGE18** (not shown)
430 Litre free standing, glass door fridge - 6 shelves

co-ordinating
personal
storage

Overbed Tables, Bedside Furniture & Patient Seating

















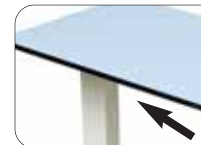

Stylish and contemporary in design, strong and durable in construction and designed to co-ordinate together. Our range of bedside furniture provides the ideal solution for storage and securing personal items. Available in a choice of finishes, all of which are designed to be easy to clean.

	PAGE
 Over Bed Tables	226-231
 new Axis & Axis Plus Bedside Locker Range	232-239
 Bedside Combination Units (Mobile)	240-241
 Bedside Cabinets	242-243
 Drawer Chests	242-243
 Wardrobes	244-245
 Atlas Patient Chairs & Seating	246-249
 Atlas Bariatric Chairs	250-251

NEW **KEYLESS** Locker Solutions...



product information

 MFC is strong, durable, and resistant to stains and heat	 Compact grade laminate is extremely strong & durable, resistant to stains, moisture, heat & scratching	 Compact grade laminate has a smooth finish, rounded corners & infection control friendly	 C-Shaped Base for overbed or chair use	 Parallel leg base for overbed or chair use
 1 Piece flat top	 Quick and easy 35cm height adjustment (between 74cm-109cm)	 Anti-trapping safety feature prevents trapping of patient between the bed & table	 Sealed tubular steel base - infection control friendly	 4 High quality swivel castors - for ease of movement
 Durable and hygienic white epoxy coating base & frame	 Safe working load (Spread evenly)	 Product Weight	 Beech, Blue and White	 FIRA Standard 6250 2005 Specification: Adhesion Performance General/Severe
 FSC the mark of responsible forestry	 Easy clean design and materials	 2 year warranty	 Supplied fully assembled	 British made

dimensions

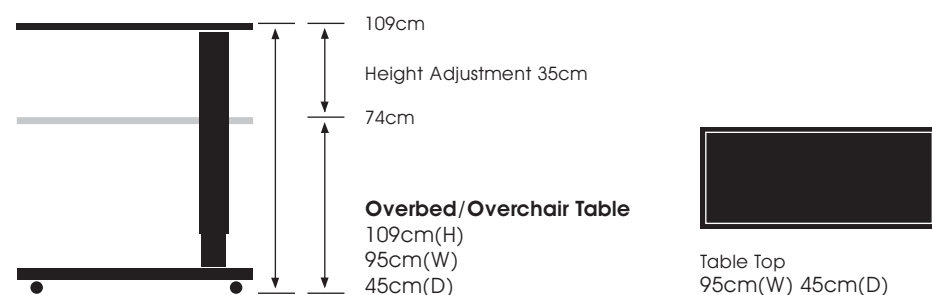

finishes

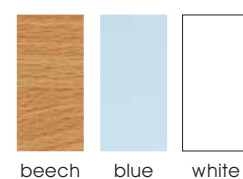

A new range of colours to match our new range of bedside lockers



Stylish & contemporary in design, strong and durable in construction, our overbed tables provide the ideal daily solution for multiple uses. Available in 5 specifically designed table tops in a choice of 3 materials, (MFC, Compact Grade Laminate and High Impact PVC/Kydex), 3 finishes and parallel or C-shaped base.

MFC is strong, durable and resistant to stains and heat.



Code: **Sun-OBT1C**
Overbed/Overchair Table with C-Shaped Base & MFC Flat Top

Code: **Sun-OBT1P**
Overbed/Overchair Table with Parallel Base & MFC Flat Top



















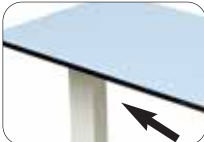

Compact Grade Laminate is a high-density fibreboard with a high strength melamine coating. It is extremely strong and durable, resistant to stains, moisture, heat and scratching. Its smooth finish and rounded edges make it exceptionally easy to clean.

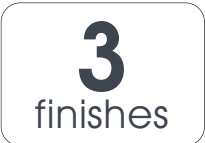

Code: **Sun-OBT2C**
Overbed/Overchair Table with C-Shaped Base & Flat Top

Code: **Sun-OBT2P**
Overbed/Overchair Table with Parallel Base & Flat Top

product information

				
Compact grade laminate is extremely strong & durable, resistant to stains, moisture, heat & scratching	Compact grade laminate has a smooth finish, rounded corners & infection control friendly	C-Shaped Base for overbed or chair use	Parallel leg base for overbed or chair use	1 Piece flat top, with raised lip (Sun-OBT3)
				
2 Piece tilting top with retaining lip (Sun-OBT4)	Retaining table top lip allows for activities such as reading	Tilting top raises from 0 - 45° (Sun-OBT4)	Quick and easy 35cm height adjustment (between 74cm-109cm)	Anti-trapping safety feature prevents trapping of patient between the bed & table
				
Sealed tubular steel base - infection control friendly	4 High quality swivel castors - for ease of movement	Durable and hygienic white epoxy coating base & frame	Safe working load	Product Weight
				
3 finishes beech, blue and white	FIRA Standard 6250 2005 Specification: Adhesion Performance General/Severe	FSC the mark of responsible forestry	Easy clean design and materials	2 year warranty
				
Supplied fully assembled	British made			

dimensions

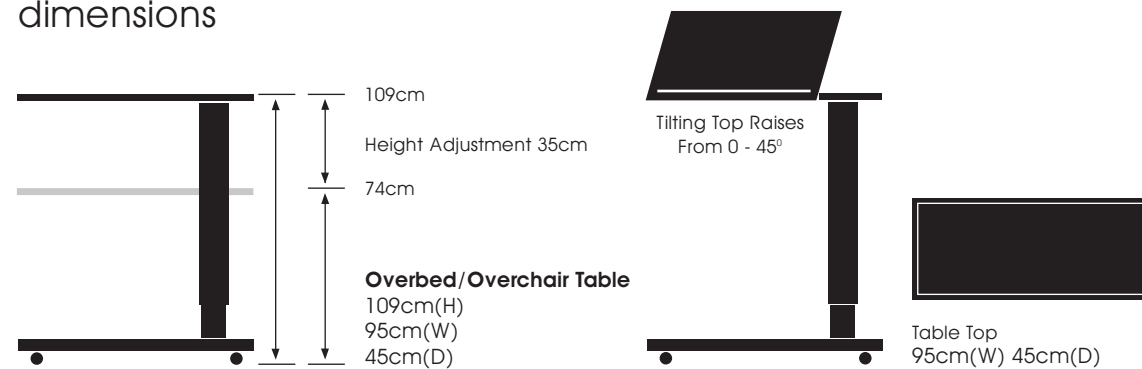

finishes

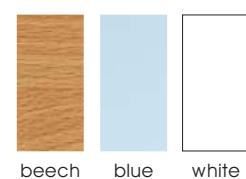

A new range of colours to match our new range of bedside lockers



Stylish & contemporary in design, strong and durable in construction, our overbed tables provide the ideal daily solution for multiple uses. Available in 5 specifically designed table tops in a choice of 3 materials, (MFC, Compact Grade Laminate and High Impact PVC/Kydex), 3 finishes and parallel or C-shaped base.



Code: **Sun-OBT3C**
Overbed/Overchair Table with C-Shaped Base & Flat Top with 1 Raised Lip



Code: **Sun-OBT3P**
Overbed/Overchair Table with Parallel Base & Flat Top with 1 Raised Lip

Compact Grade Laminate is a high-density fibreboard with a high strength melamine coating. It is extremely strong and durable, resistant to stains, moisture, heat and scratching. Its smooth finish and rounded edges make it exceptionally easy to clean.



















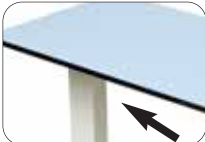



Code: **Sun-OBT4C**
Overbed/Overchair Table with C-Shaped Base & 2 Piece Tilting Top with Retaining Lip

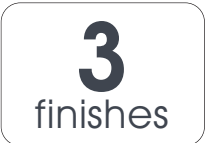

Code: **Sun-OBT4P**
Overbed/Overchair Table with Parallel Base & 2 Piece Tilting Top with Retaining Lip

product information

 High impact PVC is strong & durable, resistant to stains & heat	 High impact PVC has a smooth finish, rounded corners & infection control friendly	 C-Shaped Base for overbed or chair use	 Parallel leg base for overbed or chair use	 1 Piece recessed top (Sun-OBT5)
 2 Piece recessed tilting top (Sun-OBT6)	 Recessed table top helps to retain liquids and other items	 Tilting top raises from 0 - 45°	 Quick and easy 35cm height adjustment (between 74cm-109cm)	 Anti-trapping safety feature prevents trapping of patient between the bed & table
 Sealed tubular steel base - infection control friendly	 4 High quality swivel castors - for ease of movement	 Durable and hygienic white epoxy coating base & frame	 Safe working load 25kg	 Product Weight 20kg
 3 finishes beech, blue and white	 FIRA Standard 6250 2005 Specification: Adhesion Performance General/Severe	 FSC the mark of responsible forestry	 Easy clean design and materials	 2 year warranty
 Supplied fully assembled	 British made			

dimensions

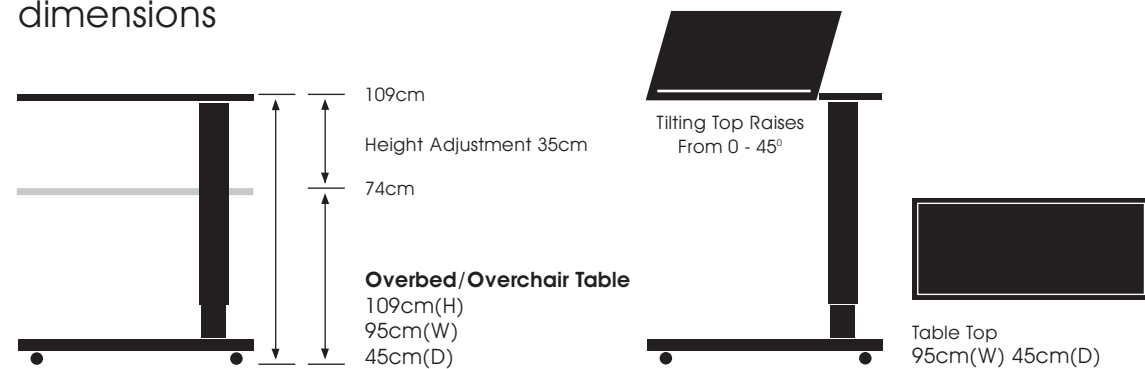

finishes

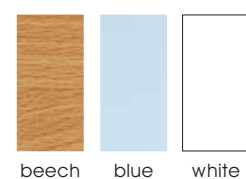

A new range of colours to match our new range of bedside lockers



Stylish & contemporary in design, strong and durable in construction, our overbed tables provide the ideal daily solution for multiple uses. Available in 5 specifically designed table tops in a choice of 3 materials, (MFC, Compact Grade Laminate and High Impact PVC/Kydex), 3 finishes and parallel or C-shaped base.



Code: **Sun-OBT5C**
Overbed/Overchair Table with C-Shaped Base & Flat Recessed Top

Code: **Sun-OBT5P**
Overbed/Overchair Table with Parallel Base & Flat Recessed Top

High Impact PVC is a heavy duty material which can be formed into recesses, providing a sealed area which can retain liquids and other items. It is strong and durable, resistant to stains and heat. Its smooth finish and rounded edges make it easy to clean and is infection control friendly.



Code: **Sun-OBT6C**
Overbed/Overchair Table with C-Shaped Base & 2 Piece Recessed Tilting Top

Code: **Sun-OBT6P**
Overbed/Overchair Table with Parallel Base & 2 Piece Recessed Tilting Top

product information - (Sun-BSL1)



product information - (Sun-BSL2)



product information - (Sun-BSL3)



product information - All Models

Integrated towel rail on back of locker	Wrapped matching rounded vinyl tops for added safety (Axis)	White tops with upstands on 3 sides in rounded vinyl finish (Axis Plus)	60mm Ø castors (front 2 braked)	"Bolted through" castors & door fixings for strength, hygiene and longevity
	18/25mm MFC	4 finishes		
Stylish satin finish easy clean handles	Manufactured chip board construction	White, Oak, Walnut and Beech	BS EN 16121: 2013 Level 2 Safety, Strength, Durability & Stability	FIRA Standard 6250 2005 Specification: Adhesion Performance General/Severe
FSC the mark of responsible forestry	Easy clean design and materials	2 year warranty	Supplied fully assembled	British made

dimensions

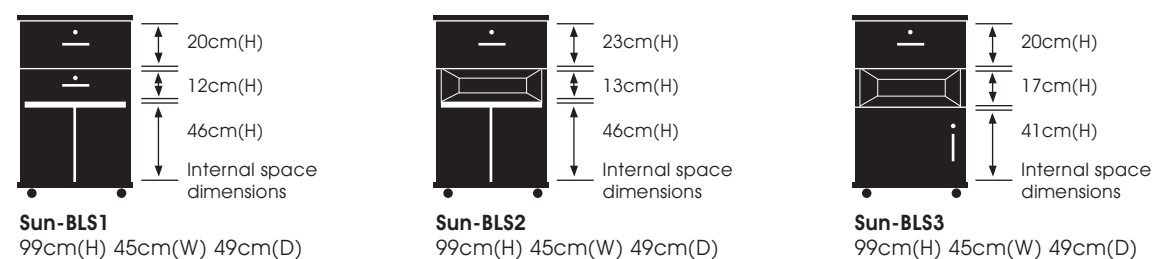

Stylish and contemporary in design, strong and durable in construction our Axis Hospital Bedside Locker range provide the ideal solution for storing and securing medicines and personal belongings on the ward. Manufactured from robust MFC material and designed to BS1765-1:1990. Our Axis bedside lockers come with rounded vinyl wrapped matching tops while the Axis Plus range has white tops with upstands on 3 sides in a rounded vinyl wrap finish. They have been designed to be cost effective, strong, easy to clean and offers good infection control performance.

Axis Bedside Lockers

Axis Plus Bedside Lockers

Lock Options



Keyed Alike Locks (KA)



Keyed to Differ Locks (KD)

Code: **Sun-BSL1/COLOUR/KA**
Axis Bedside Locker, keyed alike, large locking top drawer, locking small middle drawer, saloon bottom doors

Code: **Sun-BSL1/COLOUR/KA/WT**
Axis Plus Bedside Locker, keyed alike, white upstand top, large locking top drawer, locking small middle drawer, saloon bottom doors



Digital Combination Locks (DCL)



RFID Locks



Finishes



White (WHT) Oak (OAK)



Walnut (WAL) Beech (BCH)

Code: **Sun-BSL2/COLOUR/KA**
Axis Bedside Locker, keyed alike, large locking fold down shelf, open access shelf, saloon bottom doors

Code: **Sun-BSL2/COLOUR/KA/WT**
Axis Plus Bedside Locker, keyed alike, white upstand top, large locking fold down shelf, open access shelf, saloon bottom doors



Right or left hand hinged cupboard doors (Sun-BSL3 only)

Code: **Sun-BSL3/COLOUR/KA**
Axis Bedside Locker, keyed alike, large locking top drawer, large open access shelf, right or left hand hinged locking bottom cupboard

Code: **Sun-BSL3/COLOUR/KA/WT**
Axis Plus Bedside Locker, keyed alike, white upstand top, large locking top drawer, large open access shelf, right or left hand hinged locking bottom cupboard

product information - (Sun-BSL4)



product information - (Sun-BSL5)



product information - (Sun-BSL6)



product information - All Models

Integrated towel rail on back of locker	Wrapped matching rounded vinyl tops for added safety (Axis)	White tops with upstands on 3 sides in rounded vinyl finish (Axis Plus)	60mm Ø castors (front 2 braked)	"Bolted through" castors & door fixings for strength, hygiene and longevity
	18/25mm MFC	4 finishes		
Stylish satin finish easy clean handles	Manufactured chip board construction	White, Oak, Walnut and Beech	BS EN 16121: 2013 Level 2 Safety, Strength, Durability & Stability	FIRA Standard 6250 2005 Specification: Adhesion Performance General/Severe
FSC the mark of responsible forestry	Easy clean design and materials	2 year warranty	Supplied fully assembled	British made

dimensions

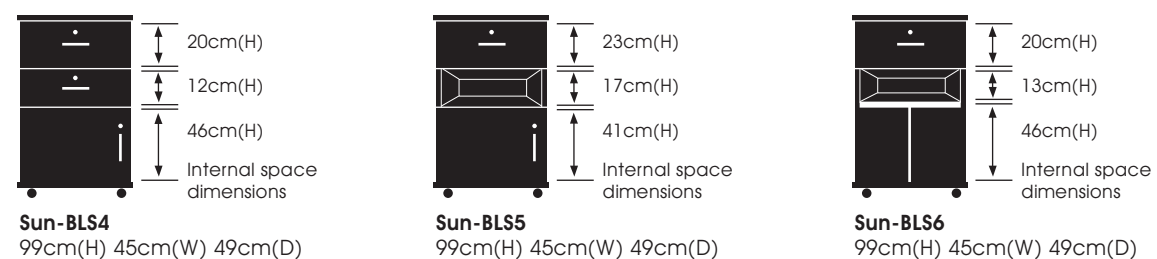

Stylish and contemporary in design, strong and durable in construction our Axis Hospital Bedside Locker range provide the ideal solution for storing and securing medicines and personal belongings on the ward. Manufactured from robust MFC material and designed to BS1765-1:1990. Our Axis bedside lockers come with rounded vinyl wrapped matching tops while the Axis Plus range has white tops with upstands on 3 sides in a rounded vinyl wrap finish. They have been designed to be cost effective, strong, easy to clean and offers good infection control performance.

Axis Bedside Lockers

Axis Plus Bedside Lockers

Lock Options



Keyed Alike Locks (KA)



Keyed to Differ Locks (KD)

Code: **Sun-BSL4/COLOUR/KA**
Axis Bedside Locker, keyed alike, large locking top drawer, locking small middle drawer, right or left hand hinged locking bottom cupboard

Code: **Sun-BSL4/COLOUR/KA/WT**
Axis Plus Bedside Locker, keyed alike, white upstand top, large locking top drawer, locking small middle drawer, right or left hand hinged locking bottom cupboard



Digital Combination Locks (DCL)



RFID Locks

Code: **Sun-BSL5/COLOUR/KA**
Axis Bedside Locker, keyed alike, large locking fold down shelf, large open access shelf, right or left hand hinged locking bottom cupboard

Code: **Sun-BSL5/COLOUR/KA/WT**
Axis Plus Bedside Locker, keyed alike, white upstand top, large locking fold down shelf, large open access shelf, right or left hand hinged locking bottom cupboard

Finishes

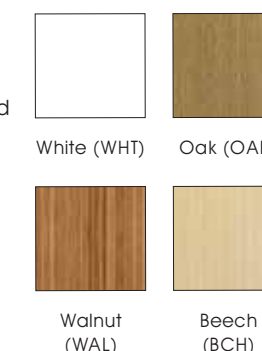

Right or left hand hinged cupboard doors (Sun-BSL4 & 5 only)

Code: **Sun-BSL6/COLOUR/KA**
Axis Bedside Locker, keyed alike, large locking top drawer, open access shelf, saloon bottom doors

Code: **Sun-BSL6/COLOUR/KA/WT**
Axis Plus Bedside Locker, keyed alike, white upstand top, large locking top drawer, open access shelf, saloon bottom doors

product information - (Sun-BSL7)



Two locking top drawers



Open access shelf for extra storage



Easy access cupboard with twin saloon doors



Built in shelf inside cupboard for storage

product information - (Sun-BSL8)



Two locking top drawers



Large open access shelf for extra storage



Locking bottom cupboard (left or right hand hinged)



Built in shelf inside cupboard for storage

product information - (Sun-BSL9/LSA)



Locking top drawer



Locking fold down shelf Left side access



Open access shelf for extra storage



Easy access cupboard with twin saloon doors



Built in shelf inside cupboard for storage

product information - All Models



Integrated towel rail on back of locker



Wrapped matching rounded vinyl tops for added safety (Axis)



White tops with upstands on 3 sides in rounded vinyl finish (Axis Plus)



60mm Ø castors (front 2 braked)



"Bolted through" castors & door fixings for strength, hygiene and longevity



Stylish satin finish easy clean handles

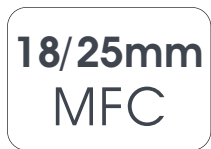

Manufactured chip board construction

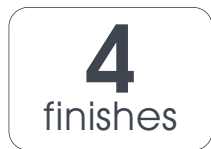

White, Oak, Walnut and Beech



BS EN 16121: 2013 Level 2 Safety, Strength, Durability & Stability



FIRA Standard 6250 2005 Specification: Adhesion Performance General/Severe



FSC the mark of responsible forestry



Easy clean design and materials



2 year warranty



Supplied fully assembled



British made

dimensions

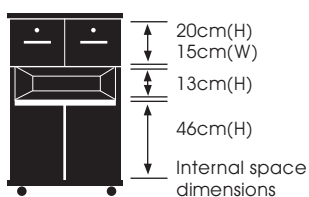

Sun-BLS7 99cm(H) 45cm(W) 49cm(D)

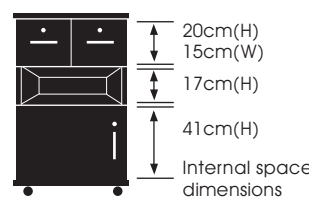

Sun-BLS8 99cm(H) 45cm(W) 49cm(D)

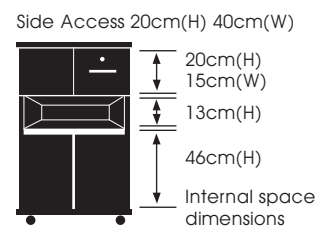

Sun-BLS9 LSA (left side access) 99cm(H) 47cm(W) 49cm(D)



Stylish and contemporary in design, strong and durable in construction our Axis Hospital Bedside Locker range provide the ideal solution for storing and securing medicines and personal belongings on the ward. Manufactured from robust MFC material and designed to BS1765-1:1990. Our Axis bedside lockers come with rounded vinyl wrapped matching tops while the Axis Plus range has white tops with upstands on 3 sides in a rounded vinyl wrap finish. They have been designed to be cost effective, strong, easy to clean and offers good infection control performance.

Axis Bedside Lockers



Code: Sun-BSL7/COLOUR/KA
Axis Bedside Locker, keyed alike, 2 locking top drawers, open access shelf, saloon bottom doors

Axis Plus Bedside Lockers



Code: Sun-BSL7/COLOUR/KA/WT
Axis Plus Bedside Locker, keyed alike, white upstand top, 2 locking top drawers, open access shelf, saloon bottom doors

Lock Options



Keyed Alike Locks (KA)



Keyed to Differ Locks (KD)



Digital Combination Locks (DCL)



RFID Locks



Code: Sun-BSL8/COLOUR/KA
Axis Bedside Locker, keyed alike, 2 locking top drawers, large open access shelf, right or left hand hinged locking bottom cupboard



Code: Sun-BSL8/COLOUR/KA/WT
Axis Plus Bedside Locker, keyed alike, white upstand top, 2 locking top drawers, large open access shelf, right or left hand hinged locking bottom cupboard

Finishes



White (WHT) Oak (OAK)



Walnut (WAL) Beech (BCH)



Code: Sun-BLS9/LSA/COLOUR/KA
Axis Bedside Locker, keyed alike, locking top drawer, locking fold down shelf, left side access, open access shelf, saloon bottom doors



Code: Sun-BLS9/LSA/COLOUR/KA/WT
Axis Plus Bedside Locker, keyed alike, white upstand top, locking top drawer, locking fold down shelf, left side access, open access shelf, saloon bottom doors



Right or left hand hinged cupboard doors (Sun-BSL8 only)

product information - (Sun-BSL9/RSA)



product information - (Sun-BSL10/LSA)



product information - (Sun-BSL10/RSA)



product information - All Models

Integrated towel rail on back of locker	Wrapped matching rounded vinyl tops for added safety (Axis)	White tops with upstands on 3 sides in rounded vinyl finish (Axis Plus)	60mm Ø castors (front 2 braked)	"Bolted through" castors & door fixings for strength, hygiene and longevity
	18/25mm MFC Manufactured chip board construction	4 finishes White, Oak, Walnut and Beech	FIRA Independently tested by FIRA BS EN 16121: 2013 Level 2 Safety, Strength, Durability & Stability	FIRA Independently tested by FIRA FIRA Standard 6250 2005 Specification: Adhesion Performance General/Severe
Stylish satin finish easy clean handles	Manufactured chip board construction	White, Oak, Walnut and Beech	BS EN 16121: 2013 Level 2 Safety, Strength, Durability & Stability	FIRA Standard 6250 2005 Specification: Adhesion Performance General/Severe
FSC the mark of responsible forestry	Easy clean design and materials	2 year warranty	Supplied fully assembled	British made

dimensions

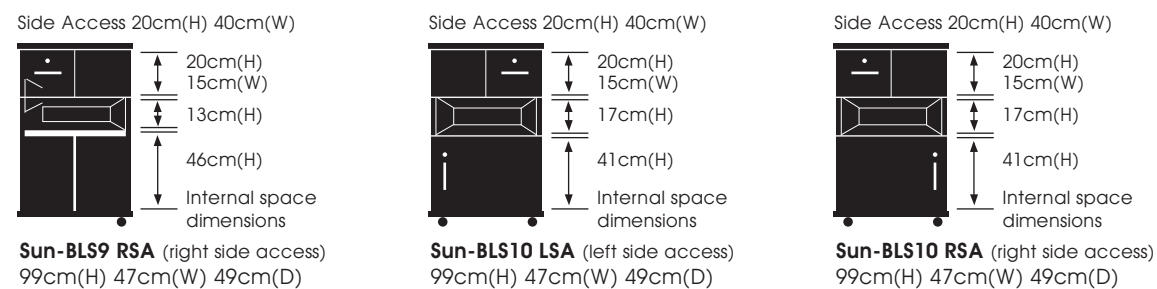

Stylish and contemporary in design, strong and durable in construction our Axis Hospital Bedside Locker range provide the ideal solution for storing and securing medicines and personal belongings on the ward. Manufactured from robust MFC material and designed to BS1765-1:1990. Our Axis bedside lockers come with rounded vinyl wrapped matching tops while the Axis Plus range has white tops with upstands on 3 sides in a rounded vinyl wrap finish. They have been designed to be cost effective, strong, easy to clean and offers good infection control performance.

Axis Bedside Lockers

Axis Plus Bedside Lockers

Lock Options



Code: Sun-BSL9/RSA/COLOUR/KA
Axis Bedside Locker, keyed alike, locking top drawer, locking fold down shelf, right side access, open access shelf, saloon bottom doors



Code: Sun-BSL9/RSA/COLOUR/KA/WT
Axis Plus Bedside Locker, keyed alike, white upstand top, locking top drawer, locking fold down shelf, right side access, open access shelf, saloon bottom doors



Keyed Alike Locks (KA)



Keyed to Differ Locks (KD)



Digital Combination Locks (DCL)



RFID Locks



Code: Sun-BSL10/LSA/COLOUR/KA
Axis Bedside Locker, keyed alike, locking top drawer, locking fold down shelf, left side access, large open access shelf, right hand hinged locking bottom cupboard



Code: Sun-BSL10/LSA/COLOUR/KA/WT
Axis Plus Bedside Locker, keyed alike, white upstand top, locking top drawer, locking fold down shelf, left side access, large open access shelf, right hand hinged locking bottom cupboard

Finishes



Code: Sun-BSL10/RSA/COLOUR/KA
Axis Bedside Locker, keyed alike, locking top drawer, locking fold down shelf, right side access, large open access shelf, left hand hinge locking bottom cupboard



Code: Sun-BSL10/RSA/COLOUR/KA/WT
Axis Plus Bedside Locker, keyed alike, white upstand top, locking top drawer, locking fold down shelf, right side access, large open access shelf, left hand hinge locking bottom cupboard



Right or left hand hinged cupboard doors

product information



Available with or without locks (2 keys per lock)



Manufactured chip board construction



Manufactured from laminate faced MDF to BS1765-1 : 1990



Conforms to British Standard BS1765-1 : 1990 (LFMDf models only)

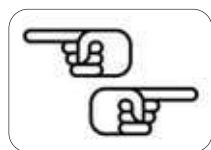

Available in left or right hand



Durable 2mm panel edging all round



Chrome hanging rail in wardrobe



60mm castors (front 2 braked)



Stylish flush fitting handles

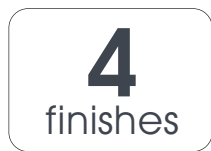

Maple, beech, oak and white



FIRA Standard 6250 2005 Specification: Adhesion Performance General/Severe



FSC the mark of responsible forestry



Easy clean design and materials



2 year warranty



Supplied fully assembled



British made

dimensions

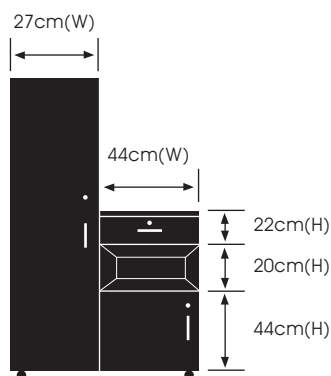

Bedside Combination Unit (Mobile)
144cm(H) 71cm(W) 49cm(D)

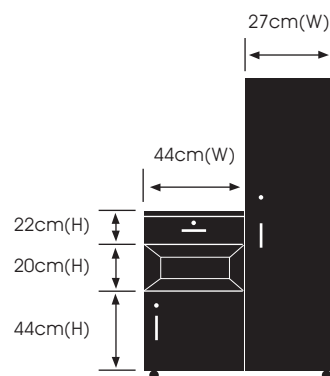

Bedside Combination Unit (Mobile)
144cm(H) 71cm(W) 49cm(D)

finishes



maple beech oak white

Stylish & contemporary in design, strong and durable in construction, our bedside combination units provide the ideal solution for storing and securing personal items. Choose from standard MFC material or LFMDf for compliance with BS1765-1:1990. Available in four finishes, all of which are designed to be easy to clean.



Left or right hand bedside combination unit with single locking wardrobe & hanging rail, locking top drawer, middle open storage recess & large locking cupboard with built in shelf.

Code: **Sun-CBHBC4/MFC/LOCKS**

Left hand bedside combination unit with locks. Manufactured from MFC material.

Code: **Sun-CBHBC4/LFMDf/LOCKS**

Left hand bedside combination unit with locks. Manufactured from laminate faced MDF material.



Code: **Sun-CBHBC5/MFC/LOCKS**

Right hand bedside combination unit with locks. Manufactured from MFC material.

Code: **Sun-CBHBC5/LFMDf/LOCKS**

Right hand bedside combination unit with locks. Manufactured from laminate faced MDF material.



Left or right hand bedside combination unit with single wardrobe & hanging rail, top drawer, middle open storage recess, & large cupboard with built in shelf.

Code: **Sun-CBHBC4/MFC**

Left hand bedside combination unit. Manufactured from MFC material.

Code: **Sun-CBHBC4/LFMDf**

Left hand bedside combination unit. Manufactured from laminate faced MDF material.



Code: **Sun-CBHBC5/MFC**

Right hand bedside combination unit. Manufactured from MFC material.

Code: **Sun-CBHBC5/LFMDf**

Right hand bedside combination unit. Manufactured from laminate faced MDF material.

product information



Locking top drawer supplied with 2 keys (Sun-CBBC1, 2 & 3 only)



Manufactured chip board construction



One drawer with large open storage recess (Sun-CBBC1 only)



One drawer and one cupboard (Sun-CBBC2 only)



Three drawers (Sun-CBBC3 only)



Five drawers (Sun-CBCD5 only)



Four drawers (Sun-CBCD4 only)



Three drawers (Sun-CBCD3 only)



Durable 2mm panel edging all round



Stylish flush fitting handles

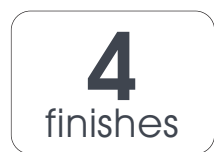

Maple, beech, oak and white



Easy clean design and materials



2 year warranty



Supplied fully assembled



FSC the mark of responsible forestry



British made

dimensions

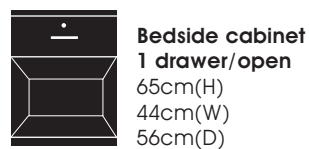

Bedside cabinet 1 drawer/open
65cm(H)
44cm(W)
56cm(D)

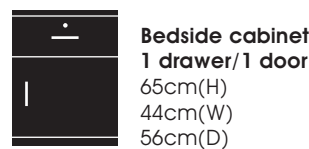

Bedside cabinet 1 drawer/1 door
65cm(H)
44cm(W)
56cm(D)

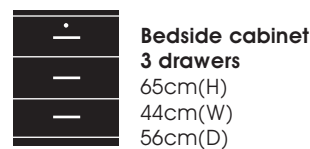

Bedside cabinet 3 drawers
65cm(H)
44cm(W)
56cm(D)

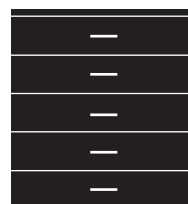

5 Drawer chest
118cm(H)
80cm(W)
59cm(D)

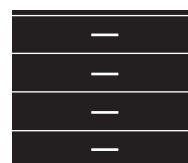

4 Drawer chest
95cm(H)
80cm(W)
59cm(D)



3 Drawer chest
72cm(H)
80cm(W)
59cm(D)

finishes



maple beech oak white

Stylish & contemporary in design, strong and durable in construction, our bedside cabinets and drawer chests provide the ideal solution for storing and securing personal items. Manufactured from MFC material. Available in four finishes, all of which are designed to be easy to clean.



Code: **Sun-CBBC1/MFC/LOCK**
Bedside cabinet with locking top drawer & large open storage recess.



Code: **Sun-CBBC2/MFC/LOCK**
Bedside cabinet with locking top drawer & large cupboard



Code: **Sun-CBBC3/MFC/LOCK**
Bedside cabinet with locking top drawer 2 additional drawers



Code: **Sun-CBDC5/MFC** - 5 drawer chest











Code: **Sun-CBDC4/MFC** - 4 drawer chest





Code: **Sun-CBDC3/MFC** - 3 drawer chest

product information

<p>18mm MFC</p>				
<p>Manufactured chip board construction</p>	<p>Two shelves (One above hanging rail and one at base)</p>	<p>Chrome hanging rail</p>	<p>Durable 2mm panel edging all round</p>	<p>Stylish flush fitting handles</p>
<p>4 finishes</p>				
<p>Maple, beech, oak and white</p>	<p>Easy clean design and materials</p>	<p>2 year warranty</p>	<p>Supplied fully assembled</p>	<p>FSC the mark of responsible forestry</p>
				
<p>British made</p>				

dimensions

HEAVY ITEM

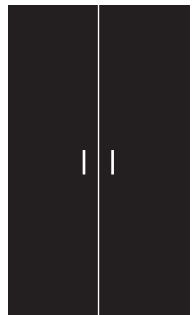
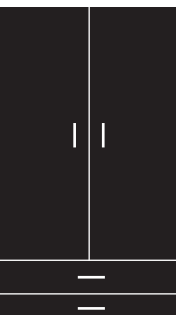
			
<p>Single wardrobe 185cm(H) 43cm(W) 60cm(D)</p>	<p>Gents single wardrobe 185cm(H) 43cm(W) 60cm(D)</p>	<p>Double wardrobe 185cm(H) 80cm(W) 60cm(D)</p>	<p>Gents double wardrobe 185cm(H) 80cm(W) 60cm(D)</p>

finishes

			
<p>maple</p>	<p>beech</p>	<p>oak</p>	<p>white</p>

Stylish & contemporary in design, strong and durable in construction, our range of wardrobes provide the ideal solution for storing personal items. Available in four finishes, all of which are designed to be easy to clean.



Code: **Sun-CBSW1/MFC**
Single wardrobe with hanging rail and 2 shelves



Code: **Sun-CBSW2/MFC**
Gents single wardrobe with hanging rail, 2 shelves and 2 drawers



Code: **Sun-CBDW1/MFC**
Double wardrobe with hanging rail and 2 shelves



Code: **Sun-CBDW2/MFC**
Gents double wardrobe with hanging rail, 2 shelves and 2 large drawers

product information

 Maximum user weight (17st.)	 Comfortable deep foam upholstery	 Solid beech frame	 Solid beech arms	 Removable seat pad for cleaning
 Optional pressure relieving foam upgrade	 Optional drop-arms to aid lateral transfer (mid & high back chairs)	 Wings for head support (Sun-CHA52 only)	 Optional adjustable height legs (10cm extension)	 Optional house keeping wheels (fitted to rear legs only)
 Vinyl or inter/vene Anti-bacterial upholstery	 5 year upholstery wearability warranty (inter/vene only)	 2 year warranty	 Supplied fully assembled	 Easy clean design and materials
 BS EN 16139: 2016 Furniture Strength, Durability and Safety Requirements	 Anti-bacterial Vinyl Strength Test BS EN ISO 13934-1: 2013 BS EN ISO 13973-3: 2000 BS EN ISO 12947-2: 1998	 Fire (Flammability) Testing Flammability BS 7176 Medium Hazard BS 5852 : 2006 Clause 11 (composites)	 British made	

accessories

* these accessories can only be fitted when ordered with the chair

 Sun-CHA48/PRF Pressure Relieving Foam Upgrade for Seat & Back	 Sun-CHA49/PRF Pressure Relieving Foam Upgrade for Seat & Back	 Sun-CHA50/PRF Pressure Relieving Foam Upgrade for Seat & Back	 Sun-CHA50/AHL* Adjustable Height Legs (10cm extension)	 Sun-CHA50/HKW* House Keeping Wheels (fitted to rear legs only)
--	--	--	---	---

upholstery colours - please specify when ordering

please see inside back cover for full specification of our upholstery range

anti-bacterial vinyl upholstery colours

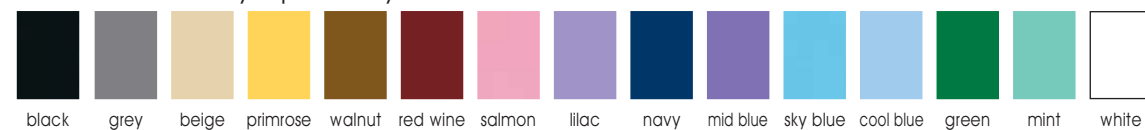

anti-bacterial inter/vene™ upholstery colours

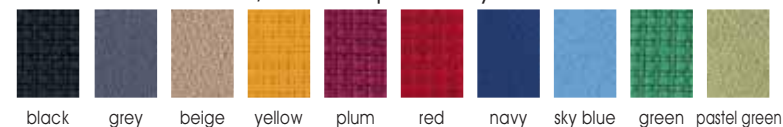

Atlas Patient Arm Chair Range

Deluxe solid beech frame upholstered seating range with deep foam padded seat and back for optimum comfort.



Code: **Sun-CHA48VYL** - Low back side chair with anti-bacterial vinyl upholstery

Code: **Sun-CHA49VYL** - Low back arm chair with anti-bacterial vinyl upholstery

Code: **Sun-CHA48IV** - Low back side chair with anti-bacterial inter/vene upholstery

Code: **Sun-CHA49IV** - Low back arm chair with anti-bacterial inter/vene upholstery



save when buying quantities of 2+ see price list for details





Code: **Sun-CHA50VYL** - Mid back arm chair with anti-bacterial vinyl upholstery

Code: **Sun-CHA50DAVYL** - Mid back arm chair with drop arms in anti-bacterial vinyl upholstery

Code: **Sun-CHA50IV** - Mid back arm chair with anti-bacterial inter/vene upholstery

Code: **Sun-CHA50DAIV** - Mid back arm chair with drop arms in anti-bacterial inter/vene upholstery

dimensions

Sun-CHA48	Sun-CHA49	Sun-CHA50	Sun-CHA50DA
			
94cm(H) 54cm(W) 63cm(D)	94cm(H) 60cm(W) 60cm(D)	104cm(H) 60cm(W) 60cm(D)	104cm(H) 60cm(W) 60cm(D)
Seat Heights 48cm - Internal Seat Widths 49cm			

product information

 Maximum user weight (17st.)	 Comfortable deep foam upholstery	 Solid beech frame	 Solid beech arms	 Removable seat pad for cleaning
 Optional pressure relieving foam upgrade	 Optional drop-arms to aid lateral transfer (mid & high back chairs)	 Wings for head support (Sun-CHA52 only)	 Optional adjustable height legs (10cm extension)	 Optional house keeping wheels (fitted to rear legs only)
 Vinyl or inter/vene Anti-bacterial upholstery	 5 year upholstery wearability warranty (inter/vene only)	 2 year warranty	 Supplied fully assembled	 Easy clean design and materials
 Independently tested by FIRA BS EN 16139: 2016 Furniture Strength, Durability and Safety Requirements	 Independently tested by FIRA Anti-bacterial Vinyl Strength Test BS EN ISO 13934-1: 2013 BS EN ISO 13973-3: 2000 BS EN ISO 12947-2: 1998	 Anti-bacterial Vinyl Fire (Flammability) Testing Flammability BS 7176 Medium Hazard BS 5852 : 2006 Clause 11 (composites)	 British made	

accessories

* these accessories can only be fitted when ordered with the chair

 Sun-CHA51/PRF Pressure Relieving Foam Upgrade for Seat & Back	 Sun-CHA52/PRF Pressure Relieving Foam Upgrade for Seat & Back	 Sun-CHA50/AHL* Adjustable Height Legs (10cm extension)	 Sun-CHA50/HKW* House Keeping Wheels (fitted to rear legs only)
--	--	---	---

upholstery colours - please specify when ordering

please see inside back cover for full specification of our upholstery range

anti-bacterial vinyl upholstery colours

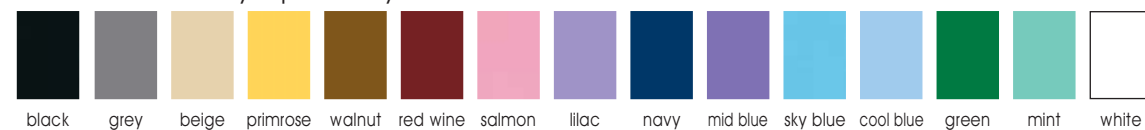

anti-bacterial inter/vene™ upholstery colours

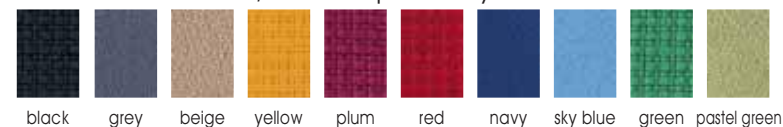

Atlas Patient Arm Chair Range

Deluxe solid beech frame upholstered seating range with deep foam padded seat and back for optimum comfort.



Code: **Sun-CHA51VYL** - High back arm chair with anti-bacterial vinyl upholstery

Code: **Sun-CHA51IV** - High back arm chair with anti-bacterial inter/vene upholstery



Code: **Sun-CHA51DAVYL** - High back arm chair with drop arms in anti-bacterial vinyl upholstery

Code: **Sun-CHA51DAIV** - High back arm chair with drop arms in anti-bacterial inter/vene upholstery



Code: **Sun-CHA52VYL** - High back arm chair with wings in anti-bacterial vinyl upholstery

Code: **Sun-CHA52IV** - High back arm chair with wings in anti-bacterial inter/vene upholstery







Code: **Sun-CHA52DAVYL** - High back arm chair with wings and drop arms in anti-bacterial vinyl upholstery

Code: **Sun-CHA52DAIV** - High back arm chair with wings and drop arms in anti-bacterial inter/vene upholstery







save when buying quantities of 2+ see price list for details

dimensions

Sun-CHA51	Sun-CHA51DA	Sun-CHA52	Sun-CHA52DA
			
117cm(H) 60cm(W) 60cm(D)	117cm(H) 60cm(W) 60cm(D)	118cm(H) 60cm(W) 60cm(D)	118cm(H) 60cm(W) 60cm(D)

Seat Heights 48cm - Internal Seat Widths 49cm

product information

 Maximum user weight (40st.)	 Comfortable deep foam upholstery	 Solid beech frame	 Solid beech arms	 Removable seat pad for cleaning
 Optional pressure relieving foam upgrade	 Optional drop-arms to aid lateral transfer (mid & high back chairs)	 Wings for head support (Sun-CHA56 only)	 Optional adjustable height legs (10cm extension)	 Optional house keeping wheels (fitted to rear legs only)
 Vinyl or inter/vene Anti-bacterial upholstery	 5 year upholstery wearability warranty (inter/vene only)	 2 year warranty	 Supplied fully assembled	 Easy clean design and materials
 Independently tested by FIRA BS EN 16139: 2016 Furniture Strength, Durability and Safety Requirements	 Independently tested by FIRA Anti-bacterial Vinyl Strength Test BS EN ISO 13934-1: 2013 BS EN ISO 13973-3: 2000 BS EN ISO 12947-2: 1998	 Anti-bacterial Vinyl Fire (Flammability) Testing Flammability BS 7176 Medium Hazard BS 5852 : 2006 Clause 11 (composites)	 British made	

accessories

* these accessories can only be fitted when ordered with the chair

 Sun-CHA55/PRF Pressure Relieving Foam Upgrade for Seat & Back	 Sun-CHA56/PRF Pressure Relieving Foam Upgrade for Seat & Back	 Sun-CHA50/AHL* Adjustable Height Legs (10cm extension)	 Sun-CHA50/HKW* House Keeping Wheels (fitted to rear legs only)
--	--	---	---

upholstery colours - please specify when ordering

please see inside back cover for full specification of our upholstery range

anti-bacterial vinyl upholstery colours

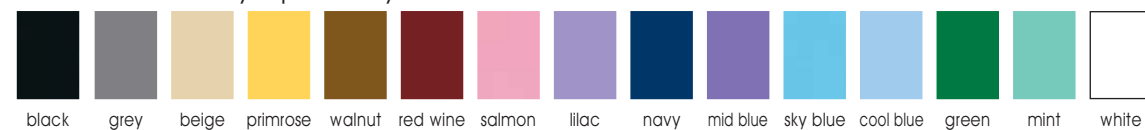

anti-bacterial inter/vene™ upholstery colours

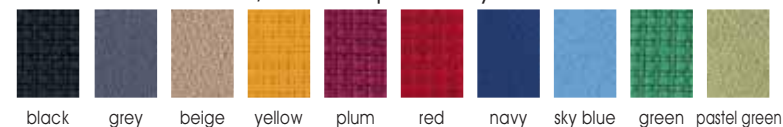

Atlas Bariatric High Back Arm Chair Range

Deluxe solid beech frame upholstered seating range with deep foam padded seat and back for optimum comfort.



Code: **Sun-CHA55VYL** - High back bariatric arm chair with anti-bacterial vinyl upholstery

Code: **Sun-CHA55DAVYL** - High back bariatric arm chair with drop arms in anti-bacterial vinyl upholstery

Code: **Sun-CHA55IV** - High back bariatric arm chair with anti-bacterial inter/vene upholstery

Code: **Sun-CHA55DAIV** - High back bariatric arm chair with drop arms in anti-bacterial inter/vene upholstery







Code: **Sun-CHA56VYL** - High back bariatric arm chair with wings in anti-bacterial vinyl upholstery

Code: **Sun-CHA56DAVYL** - High back bariatric arm chair with wings and drop arms in anti-bacterial vinyl upholstery

Code: **Sun-CHA56IV** - High back bariatric arm chair with wings in anti-bacterial inter/vene upholstery

Code: **Sun-CHA56DAIV** - High back bariatric arm chair with wings and drop arms in anti-bacterial inter/vene upholstery

dimensions

Sun-CHA55	Sun-CHA55DA	Sun-CHA56	Sun-CHA56DA
			
110cm(H) 93cm(W) 73cm(D)	110cm(H) 93cm(W) 73cm(D)	126cm(H) 93cm(W) 73cm(D)	126cm(H) 93cm(W) 73cm(D)

Seat Heights 51cm - Internal Seat Widths 81cm

Recommended Material Cleaning Guidelines:



We make every effort during our design process to ensure our products are easy to clean and utilise modern materials and processes where possible to assist in the prevention of cross infection. We recommend that all surfaces should be thoroughly cleaned and disinfected regularly, and have compiled the following guidelines to assist you with your cleaning process:

Vinyl & Intervene Upholstery:

- Alcohol based wipes are acceptable as a cleaning method such as Clinell Universal Wipes. Vigorous wiping can be used on the vinyl upholstery but the use of abrasive materials is not recommended as it will lead to scratching and damage to the surface.
- Hypochlorite based cleaning can be undertaken up to 10000ppm. Particular care must be taken to avoid pooling of cleaning substance as concentrations increase with evaporation and cause damage.
- Hypochlorite cleaning can, over time, cause discolouration and eventually hardening and cracking. In real world use in hospitals Sunflower has not seen this to be a problem but it is a potential issue regardless of the manufacturer of the furniture.
- All wetness must be dried after cleaning with care been taken to dry into joints.

KYDEX and Plastic Components:

- Alcohol based wipes are acceptable as a cleaning method such as Clinell Universal Wipes. Vigorous wiping can be used on the Kydex and Plastic but the use of abrasive materials is not recommended as it will lead to scratching and damage to the surface.
- Hypochlorite based cleaning can be undertaken up to 10000ppm. Particular care must be taken to avoid pooling of cleaning substance as concentrations increase with evaporation and cause damage.
- All wetness must be dried after cleaning with care been taken to dry into joints.

Powder Coating (Paint):

- Powder coated surfaces (paint) should be cleaned using a soft damp non-abrasive cloth & wiped dry. Increased or continual exposure to wet/damp conditions or environments of high humidity may result in rusting/or cause the coating to peel, and therefore is not recommended. Some dulling of the finish may occur over time if cleaning products are consistently used.
- Hypochlorite based cleaning can be undertaken up to 10000ppm. Particular care must be taken to avoid pooling of cleaning substance as concentrations increase with evaporation and cause damage.
- Bleach, bleach based sprays, solvents, abrasives, synthetic detergents, wax polishes or aerosols are not recommended.

Melamine, Laminates & Vinyl Wrapping:

- Melamine & Laminate faced surfaces (used on MFC & MDF) should be cleaned using a soft damp non-abrasive cloth and wiped dry.
- Vinyl wrapped surfaces (e.g. Doors & Drawers) should be cleaned using a soft damp non-abrasive cloth and wiped dry.
- Hypochlorite based cleaning can be undertaken up to 10000ppm. Particular care must be taken to avoid pooling of cleaning substance as concentrations increase with evaporation and cause damage.
- Bleach, bleach based sprays, solvents, abrasives, synthetic detergents, wax polishes or aerosols are not recommended.

Stainless Steel:

- Stainless steel surfaces should be cleaned using a soft damp non-abrasive cloth and wiped dry. Discolouration may occur if allowed to dry naturally. Stainless steel can still rust and certain chemicals can still damage the material. Iodine is one particular chemical which is known to corrode/stain and should be avoided for cleaning. Increased or continual exposure to wet/damp conditions or environments of high humidity may result in some rusting and therefore is not recommended.
- Hypochlorite based cleaning can be undertaken up to 10000ppm. Particular care must be taken to avoid pooling of cleaning substance as concentrations increase with evaporation and cause damage.

Aluminium:

- Aluminium surfaces should be cleaned using a soft damp non-abrasive cloth and wiped dry. Discolouration may occur if allowed to dry naturally. Increased or continual exposure to wet/damp conditions or environments of high humidity may result in corrosion and therefore is not recommended.

- Bleach, bleach based sprays, solvents, abrasives, synthetic detergents, wax polishes or aerosols are not recommended.

Plastics, PVC & Rubber Based Materials:

- Plastics, PVC (e.g. screen panels) & rubber should be cleaned using a soft damp non-abrasive cloth and wiped dry.
- Bleach, bleach based sprays, solvents, abrasives, synthetic detergents, wax polishes or aerosols are not recommended.

Electrical Components, Wiring & Actuators:

- Any electrical components should not be exposed to water, liquids or areas of high humidity. Plastic casings, wires and handsets can be cleaned using a soft damp non-abrasive cloth and wiped dry.
- Bleach, bleach based sprays, solvents, abrasives, synthetic detergents, wax polishes or aerosols are not recommended.

- Always switch off the mains supply before cleaning.

Metal or MFC Components:

- Alcohol based wipes are acceptable as a cleaning method such as Clinell Universal Wipes. Vigorous wiping can be used on the body but the use of abrasive materials is not recommended as it will lead to scratching and damage to the surface.
- Hypochlorite based cleaning can be undertaken up to 10000ppm. Particular care must be taken to avoid pooling of cleaning substance as concentrations increase with evaporation and cause damage.

- All wetness must be dried after cleaning with care been taken to dry into joints. Failure to dry full can lead to paint work damage and rusting over time.

- Particular care must be taken no ensure that no liquids or cleaning materials enter the mechanism of locks. This will cause premature failure.

Castors:

- Castors due to their nature pick up "fluff and bits". Initially before wet cleaning all "fluff and bits" should be removed by hand. Once these are removed then further cleaning can be undertaken as below.

- Alcohol based wipes are acceptable as a cleaning method such as Clinell Universal Wipes. Vigorous wiping can be used on the castor but the use of abrasive materials is not recommended as it will lead to scratching and damage to the surface.

- Hypochlorite based cleaning can be undertaken up to and 10000ppm. Particular care must be taken to avoid pooling of cleaning substance as concentrations increase with evaporation and cause damage.

- All wetness must be dried after cleaning with care been taken to dry into joints.

Shelves and Trays:

- The shelves and trays should be cleaned individually. They should be fully wiped on all surfaces and repositioned in the trolley as cleaning is undertaken.

- Alcohol based wipes are acceptable as a cleaning method such as Clinell Universal Wipes. Vigorous wiping can be used on the shelves and trays but the use of abrasive materials is not recommended as it will lead to scratching and damage to the surface.

- Hypochlorite based cleaning can be undertaken less up to and including 10000ppm. Particular care must be taken to avoid pooling of cleaning substance as concentrations increase with evaporation and cause damage.

We design medical furniture to help healthcare become more efficient, combined with high service levels, extensive warranties and consideration for the environment.

We believe passionately in innovative design and continuous development, utilise modern materials and technology to produce stylish and hygienic new products and solutions.

Ease of cleaning and hygienic design is carefully incorporated into everything we do.

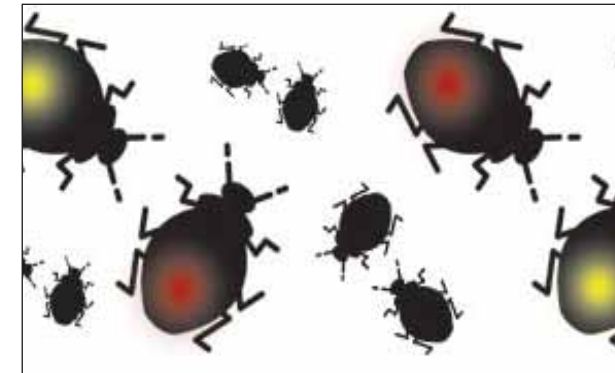

Infection Control

The requirement for furniture that provides functional, ergonomic hygienic storage which assists in minimising infection control issues has always been a significant factor in our design and manufacturing processes and one of continuous improvement. Smart design such as sloping top wall units help facilitate cleaning and the build-up of dust as well as preventing the storage of items which should ideally be stored elsewhere. Materials which are durable and hard wearing, moisture resistant and anti-bacterial can all be utilised as part of our furniture and storage solutions.



Environment

We are committed to reducing our impact on the environment and utilise sustainable materials and sources wherever possible. Our cabinet and worktop manufacturing processes are optimised to be as efficient as possible, reducing energy costs and minimising waste. Reducing our carbon footprint through an on-going reduction programme is part of our company process and our ISO 14001 Environmental Quality Standard Certification and FSC Accreditation (the Mark of Responsible Forestry) shows our commitment to reducing our environmental impact even further.



Certified Number 5288
ISO 9001



Certified Number 5288
ISO 14001



FSC The mark of
responsible forestry



Membership No:
00334186



FIRA Standard 6250
2005 Specification:
Adhesion Performance
General/Severe



BS EN 16139: 2013
Furniture Strength,
Durability & Safety



Anti-bacterial Vinyl Strength Test
BS EN ISO 13934-1: 2013
BS EN ISO 13973-3: 2000
BS EN ISO 12947-2: 1998



Fire (Flammability) Testing
Flammability BS 7176 Medium Hazard
BS 5852 : 2006 Clause 11
(composites)

Anti-bacterial Vinyl Upholstery

Composition:

- Top Coating 100% PVC
- Backing Cloth 100% Polyester

Flame Retardancy:

- BS5852 Ignition Source 5
- BS7176 Medium Hazard
- CRIB Test BS 585 : 2006

Effectiveness:

- Independent testing has verified effective reduction in the spread of MRSA E.coli and other similar bacteria
- Anti-microbial JIS Z 2801 : 2000

Abrasion:

- Martindale rubs 100,000+

Cleaning:

Alcohol based wipes are acceptable as a cleaning method such as Clinell Universal Wipes. Vigorous wiping can be used on the vinyl upholstery but the use of abrasive materials is not recommended as it will lead to scratching and damage to the surface.

Hypochlorite based cleaning can be undertaken upto 10000ppm. Particular care must be taken to avoid pooling of cleaning substance as concentrations increase with evaporation and cause damage.

Hypochlorite cleaning can, over time, cause discolouration and eventually hardening and cracking. In real world use in hospitals Sunflower has not seen this to be a problem but it is a potential issue regardless of the manufacturer of the furniture.

All wetness must be dried after cleaning with care been taken to dry into joints

upholstery colours

colours - please specify when ordering



Inter/Vene™ Anti-bacterial Upholstery

Composition:

- 100% Recycled Polyester FR
- Non metallic dyestuffs

Flame Retardancy:

- Fire Retardant (Class 1) BS7176 (Crib 5)
- BS EN 1021 - 1:2006 (cigarette)
- BS EN 1021 - 2:2006 (match)
- BS 5852 : 2006 Section 4 Ignition Source 5
- BS 7176 : 2007 Medium Hazard

Abrasion:

- Martindale rubs 100,000
- 5 year wearability guarantee (8 hour usage)

Effectiveness:

- Anti-bacterial/ Anti-microbial, inhibits microbial growth of Staph Aureus, Altinata, salmonella, Aspergillus Niger, Penicillium, Staphylococcus Aureus, Cladosporium Herbarism, MRSA
- Completely Waterproof
- Urine Proof BS3424 part 19
- Topical stain repellent and stain resistant finish
- Breathable: Vapour permeable BS3546
- Bleach Cleanable: Colour fastness to chlorine bleach BS EN ISO E03

Cleaning:

Alcohol based wipes are acceptable as a cleaning method such as Clinell Universal Wipes. Vigorous wiping can be used on the vinyl upholstery but the use of abrasive materials is not recommended as it will lead to scratching and damage to the surface.

Hypochlorite based cleaning can be undertaken upto 10000ppm. Particular care must be taken to avoid pooling of cleaning substance as concentrations increase with evaporation and cause damage.

Hypochlorite cleaning can, over time, cause discolouration and eventually hardening and cracking. In real world use in hospitals Sunflower has not seen this to be a problem but it is a potential issue regardless of the manufacturer of the furniture.

All wetness must be dried after cleaning with care been taken to dry into joints

KYDEX® - Thermoplastic Covering

Antifungal & Antibacterial Properties:

KYDEX® sheet resists bacteriological and fungal development which makes it ideal for use in hospitals, food industry, etc. It does not readily provide a source of nutrients for bacteria and fungi. One source of these nutrients come from an additive known as a plasticizer, which in most cases will support microbial growth. Since it does not contain plasticizers, the main source of nutrients is removed and it performs very well when tested for bacterial and fungal growth.

KYDEX® sheet was subjected to fungus resistance testing in accordance with ASTM G-21 and bacteria resistance testing in accordance with ASTM G-22, Procedure B.

The KYDEX® sheet samples did not allow any fungus or bacteria growth and performs exceptionally when exposed to bacteria and fungus, without the addition of an anti-microbial additive.

Chemical Resistance:

From sulphuric acid to brake fluid to carbon tetrachloride, KYDEX® thermoplastic alloy is more resistant to a wider range of concentrated chemicals than any other thermoplastic. All grades of KYDEX® sheet meet the highest standards of chemical resistance for thermoplastic materials and pass the NHS's requirement for 1000ppm Hypochlorite solution cleaning.

FDA Compliance:

The Food and Drug Administration's (FDA's) regulations allows each KYDEX® 107 ingredient to be used in contact with food, making it ideal for overbed tables.

Cleaning:

Alcohol based wipes are acceptable as a cleaning method such as Clinell Universal Wipes. Vigorous wiping can be used on the Kydex but the use of abrasive materials is not recommended as it will lead to scratching and damage to the surface.

Hypochlorite based cleaning can be undertaken upto 10000ppm. Particular care must be taken to avoid pooling of cleaning substance as concentrations increase with evaporation and cause damage.

All wetness must be dried after cleaning with care been taken to dry into joints.

COLOURS - please specify when ordering



COLOURS - please specify when ordering





Sunflower Medical Limited

17 Roydsdale Way
Euroway Trading Estate
Bradford
BD4 6SE
United Kingdom

T: +44 (0)1274 684004

UK Enquiries

E: sales@sunflowermedical.co.uk

International Enquiries

E: export@sunflowermedical.co.uk

W: www.sunflowermedical.co.uk



Certificate Number 5288
ISO 9001



Certificate Number 5288
ISO 14001



All descriptions, specifications & particulars contained in this brochure are intended merely to represent a general idea of the goods described herein and none of these form part of any contract or give rise to any independent collateral liability upon the company. Our policy is one of continuous improvement and we reserve the right to change specifications, prices and designs at any time without notice. All colours and finishes in this brochure are as accurate as the printing process will allow.